



**Seamless Presentation Switch with Quad View
Multistreaming**

VP2120 User Manual



EMC Information

FEDERAL COMMUNICATIONS COMMISSION INTERFERENCE

STATEMENT: This equipment has been tested and found to comply with the limits for a Class A digital device, pursuant to Part 15 of the FCC Rules. These limits are designed to provide reasonable protection against harmful interference when the equipment is operated in a commercial environment. This equipment generates, uses, and can radiate radio frequency energy and, if not installed and used in accordance with the instruction manual, may cause harmful interference to radio communications. Operation of this equipment in a residential area is likely to cause harmful interference in which case the user will be required to correct the interference at his own expense.

FCC Caution: Any changes or modifications not expressly approved by the party responsible for compliance could void the user's authority to operate this equipment.

Warning: Operation of this equipment in a residential environment could cause radio interference.

This device complies with Part 15 of the FCC Rules. Operation is subject to the following two conditions:

- (1) this device may not cause harmful interference, and
- (2) this device must accept any interference received, including interference that may cause undesired operation.

RoHS

This product is RoHS compliant.



User Information

Online Registration

Be sure to register your product at our online support center:

International	http://eservice.aten.com
---------------	---

Telephone Support

For telephone support, call this number:

International	886-2-8692-6959
China	86-400-810-0-810
Japan	81-3-5615-5811
Korea	82-2-467-6789
North America	1-888-999-ATEN ext 4988 1-949-428-1111

User Notice

All information, documentation, and specifications contained in this manual are subject to change without prior notification by the manufacturer. The manufacturer makes no representations or warranties, either expressed or implied, with respect to the contents hereof and specifically disclaims any warranties as to merchantability or fitness for any particular purpose. Any of the manufacturer's software described in this manual is sold or licensed as *is*. Should the programs prove defective following their purchase, the buyer (and not the manufacturer, its distributor, or its dealer), assumes the entire cost of all necessary servicing, repair and any incidental or consequential damages resulting from any defect in the software.

The manufacturer of this system is not responsible for any radio and/or TV interference caused by unauthorized modifications to this device. It is the responsibility of the user to correct such interference.

The manufacturer is not responsible for any damage incurred in the operation of this system if the correct operational voltage setting was not selected prior to operation. PLEASE VERIFY THAT THE VOLTAGE SETTING IS CORRECT BEFORE USE.

Package Contents

- ◆ 1 VP2120 Seamless Presentation Switch with Quad View Multistreaming
- ◆ 1 IR Receiver
- ◆ 1 IR Remote Control
- ◆ 1 Power Adapter
- ◆ 1 User Instructions

Note: Make sure that all of the items are present and in good order. If anything is missing or was damaged in shipping, please contact your dealer for further assistance.

Table of Contents

EMC Information	ii
RoHS	ii
User Information	iii
Online Registration	iii
Telephone Support	iii
User Notice	iii
Package Contents	iv
About this Manual	viii
Conventions	ix
Product Information	ix

1. Introduction

Overview	1
Features	2
Planning the Installation	4
Required Equipment	4
Optional Equipment and Accessories	4
Equipment	4
Accessories	4

2. Hardware Setup

Components	5
VP2120 Front View	5
VP2120 Rear View	6
IR Remote Control	7
LED Display	8
Mounting	9
Rack Mount	9
Under Desk Mount	10
Installation	11

3. Local Operation

Overview	13
Operation Considerations	13
Displaying the Room Info	14
The OSD	15
Switching the Sources	17
Display Settings and Behavior	19
Display Mode	19
Multiview Display for Streamed-in Sources	20
Streaming Out a Display	22
Overview	22
Using the IR Remote Control	22

Using the OSD	23
Getting Screen Captures	24
Whiteboard	25
Using the IR Remote Control	25
Using the OSD	26
Viewing Event Logs	27
Locking the Front Panel	28
System Settings	28

4. Remote Operation

Overview	33
The VP2120's IP Address	33
Account Types and Privileges	34
Supported Web Browsers	34
The Administrator Account	35
Logging in as Administrator	35
The Administrator Screen	37
Configuration View	37
Presentation View	38
Sharing a Screen or an Application Window	40
Whiteboard	42
How to Insert Text	43
Control Panel	44
Video	45
Audio	47
Settings	48
System Configuration	50
General Settings	50
Audio Settings	53
Display Settings	54
Maintenance	56
Network Settings	58
The Participant Account	59
Joining a Meeting as Participant via Web Interface	59
The Participant Screen	60
Joining a Meeting as Participant via App	62
Requirements	62
Procedure	62
iOS	63
Android	66

Appendix

Safety Instructions	69
General	69
Rack Mounting	71
Technical Support	72

International 72
North America 72
Specifications 73
Limited Warranty 75

About this Manual

This user manual is provided to help you get the most from the VP2120 unit. It covers all aspects of installation, configuration, and operation. An overview of the information found in the manual is provided below.

Chapter 1, *Introduction* introduces you to the VP2120. Its purpose, features, benefits, and installation considerations are described.

Chapter 2, *Hardware Setup* introduces the hardware components of the VP2120 and provides information on how to quickly and safely set up the unit.

Chapter 3, *Local Operation* provides information on operation of the VP2120 using the panel pushbuttons and IR remote control.

Chapter 4, *Remote Operation* provides details on remote tasks such as joining online meetings and system configuration via the web interface and the ATEN Video Presentation Control App.

An Appendix provides a list of safety instructions and precautions, contact information for ATEN technical support, product specifications, and other technical information.

Note:

- ◆ Read this manual thoroughly and follow the installation and operation procedures carefully to prevent any damage to the unit or any connected devices.
 - ◆ ATEN regularly updates its product documentation for new features and fixes. For an up-to-date VP2120 documentation, visit <http://www.aten.com/global/en/>
-

Conventions

This manual uses the following conventions:

- `Monospaced` Indicates text that you should key in.
- [] Indicates keys you should press. For example, [Enter] means to press the **Enter** key. If keys need to be chorded, they appear together in the same bracket with a plus sign between them: [Ctrl+Alt].
1. Numbered lists represent procedures with sequential steps.
- ◆ Bullet lists provide information, but do not involve sequential steps.
- Indicates selecting the option (on a menu or dialog box, for example), that comes next. For example, Start → Run means to open the *Start* menu, and then select *Run*.
-  Indicates critical information.

Product Information

For information about all ATEN products and how they can help you connect without limits, visit ATEN on the Web or contact an ATEN Authorized Reseller. Visit ATEN on the Web for a list of locations and telephone numbers:

International	http://www.aten.com
North America	http://www.aten-usa.com

This Page Intentionally Left Blank

Chapter 1

Introduction

Overview

The VP2120 is a Seamless Presentation Switch that integrates video matrix switch, quad-view multistreaming, audio DSP, and idea-sharing platform into one compact device. With the seamless switching between streamed-in sources, the online idea exchanging features, and the network capability that enables the wireless connection for mobile devices, the VP2120 and ATEN Video Presentation Control App empower wireless BYOD collaboration anytime when a short catch-up, quick meeting, instant brainstorm, stand-up, or ad hoc call is needed.

Designed for flexible and spontaneous team collaboration, the VP2120 along with ATEN Video Presentation Control App facilitates BYOD meetings with the straightforward user interface that give users quick and easy access to any on-the-fly meetings. Joining an online meeting is easy and secure. Participants can just bring their own devices and use the private QR code or room code, or auto scan the local network to get available room list to log in, even when they're not physically in the same area. The VP2120 allows bi-directional content streaming of up to 4 participants simultaneously. With the built-in multi-view mode, the streamed sources can be displayed on the same screen, which the layout dynamically adjusts to suit the number of sources available. Participants can also focus a streaming input to display full screen or view the go-live screen together for synchronization. Moreover, the built-in audio DSP allows remote participants to broadcast to meeting members using their own devices, with the sound mixed with the program audio.

The VP2120 along with ATEN Video Presentation Control App also features more advanced online idea-sharing functions: Whiteboard allows real-time annotation for idea exchange and synchronization; Chat Room feature enhances interaction between participants; File Sharing enables further data sharing and follow-up; while the screen capture function records the meeting process for future tracking. This Collaborative presentation solution facilitates any forms of small-group discussion that gives an immediate boost to team work.

Features

Brilliant AV Routing

- ◆ One HDMI input and dual HDMI outputs plus 4 bi-directional streaming with matrix display support
- ◆ Seamless Switching between streamed-in sources for fast idea exchange
- ◆ Audio DSP - Mix Mic input, HDMI input, and the last streaming input for HDMI or audio output
- ◆ HDMI audio de-embedding support

Launch a Quick Meeting Anytime

- ◆ Launches wireless BYOD collaboration via Web GUI and Mobile App in a swift and agile way
- ◆ Offers quick and easy access to log in a quick meeting via multiple methods:
 - ◆ Start auto scan and select a room number from the list
 - ◆ Scan the QR code shown on the VP2120 OSD
 - ◆ Load a pre-saved QR code
 - ◆ Input the IP address and Room code shown on the OSD

Seamless BYOD Collaboration

- ◆ Multiple control method via front-panel pushbuttons, web GUI, OSD, IR remote, and mobile App
- ◆ Streaming in – view up to 4 streamed-in contents simultaneously for real-time synchronization
- ◆ Streaming out – allows log-in participants to view the Go-live contents on personal devices
- ◆ Multi-view with Auto layout – dynamically adjusts the layout to suit the number of streamed-in sources available
- ◆ Whiteboard allows real-time annotation for idea exchange and synchronization
- ◆ Chat room feature enhances text interaction and information sharing
- ◆ Screen capture records the meeting process for future tracking
- ◆ File sharing enables further data sharing and follow-up

High-definition Video with Optimum Output

- ◆ Superior video quality up to 1920 x 1080 with single streaming input and 854 x 480 with four streaming inputs
- ◆ EDID Expert™ – automatically selects the optimum EDID settings for smooth power-up, high-quality display, and the best video resolution across connected devices
- ◆ HDMI (1080p); CEC (Consumer Electronics Control); HDCP 1.4 compliant

Planning the Installation

Required Equipment

Prepare the following equipment before installing the VP2120 unit.

- ◆ Source devices
 - ◆ 1 source device equipped with an HDMI port

Note: The VP2120 supports Mac or PCs that are Windows, Linux, or Unix-based.

- ◆ 1 HDMI cable for connecting the source devices to the VP2120
- ◆ Display devices
 - ◆ 1 or 2 display devices equipped with an HDMI connector (e.g. a monitor or a projector)
 - ◆ 1 or 2 cables for connecting the display devices to the VP2120

For information on the number of equipped ports for each connection interface, see *Specifications*, page 75.

Optional Equipment and Accessories

Equipment

Prepare the following equipment as required.

- ◆ 1 Microphone
- ◆ 1 Speaker
- ◆ 1 RJ-45 cable to connect the VP2120 to a network switch to allow for streaming over IP and access to the VP2120's web interface
- ◆ 1 to 4 wireless device to connect with the VP2120 for presentation viewing and sharing.

Accessories

Optionally purchase the following for your VP2120.

- ◆ Rack Mount Kit
- ◆ Under Desk Mount Kit

For more information about mounting, see *Mounting*, page 9.

Chapter 2

Hardware Setup



1. Please review the safety information regarding the placement of this device in *Safety Instructions*, page 71.
2. Do not power on the VP2120 until all the necessary hardware is connected.

Components

VP2120 Front View

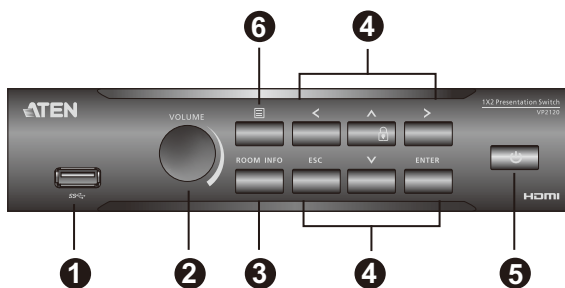

No.	Component	Description
1	USB Type-A Port (3.0)	Receives a USB 3.0 device such as an external storage.
2	Volume Control	Turn to adjust the volume or press the knob to mute.
3	Room Info Pushbutton	Press to display the room information such as room name, IP address of the web interface, room code, and QR code to access the meeting.
4	Navigation Pushbuttons	Press to navigate and configure the system settings via the OSD.
5	Power Pushbutton	Press to turn on the VP2120 unit.
6	Menu Pushbutton	Press to display the OSD on display A. Note: OSD can only be displayed on display A.

VP2120 Rear View

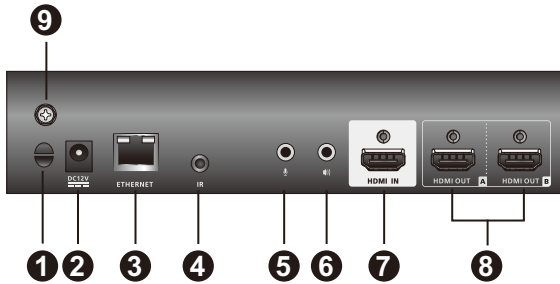

No.	Component	Description
1	Cable Tie Slot	Receives a cable tie to hold the power cable in place.
2	Power Jack	Receives a power adapter to supply power to the VP2120.
3	Ethernet Port	Connects to a network switch via an RJ-45 cable to allow streaming of audio and video data over IP.
4	IR Receiver Port	Connects to an IR receiver to receive IR signals from the IR remote control.
5	Mic In	Connects to a microphone.
6	Stereo Audio Out	Connects to a speaker.
7	HDMI In Port	Connects to an HDMI source device via HDMI cable.
8	HDMI Out Ports	Connect to display devices equipped with an HDMI port.
9	Grounding Terminal	Grounds the VP2120 to prevent damages from power surge or static electricity.

IR Remote Control

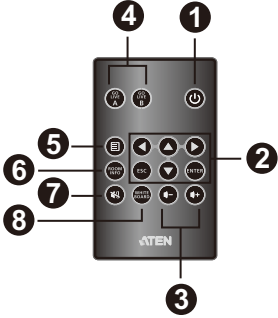

No.	Buttons	Description
1	On/Off	Turns the VP2120 on or off.
2	Navigation	Navigates in the OSD, selects or unselects options, or leaves a current screen in the OSD.
3	Volume Control	Adjusts the volume up and down.
4	Go Live	Select to stream out display between display A or display B via the Ethernet.
5	Menu	Displays the OSD on display A. Note: The OSD can only be displayed on display A.
6	Room Info	Displays room information.
7	Mute	Mutes all displays and speakers.
8	Whiteboard	Displays the whiteboard on display A. Note: Whiteboard can only be displayed on display A.

LED Display

You can find the unit's LEDs as illustrated below. See the table below for details on LED indication.

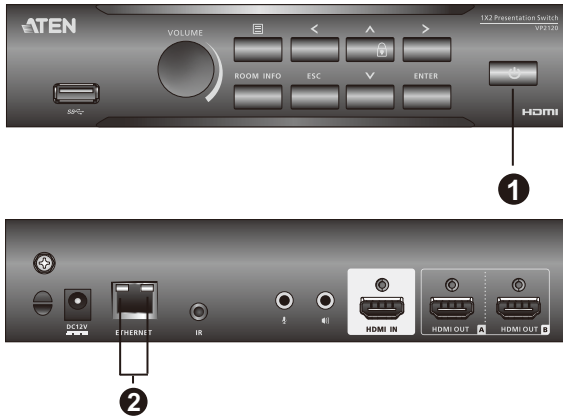

No.	LED	Indication	Description
1	Power	Lights green	The unit is powered and switched ON .
		Lights orange	The unit is connected to power, but is currently OFF .
2	ACT (Left LED)	Lights orange	Data is being transmitted at 100 Mbps.
		Lights green	Data is being transmitted at 1 Gbps.
	Link (Right LED)	Lights green	LAN is connected and no data is being transmitted.
		Blinks green	LAN is connected and data is being transmitted.

Mounting

Rack Mount

The VP2120 can be mounted on a 19" (1U) system rack. To conveniently access the front-panel pushbuttons for local configuration and operation, mount the unit at the front of the rack so that the front panel faces outward.

Note: The Rack Mount Kit required for this installation is not included in the package. For more information on purchasing this accessory, please visit the product web page.

1. Use the 4 M3 Phillips hex head screws supplied with the mounting kit to secure the rack mounting brackets onto the unit.

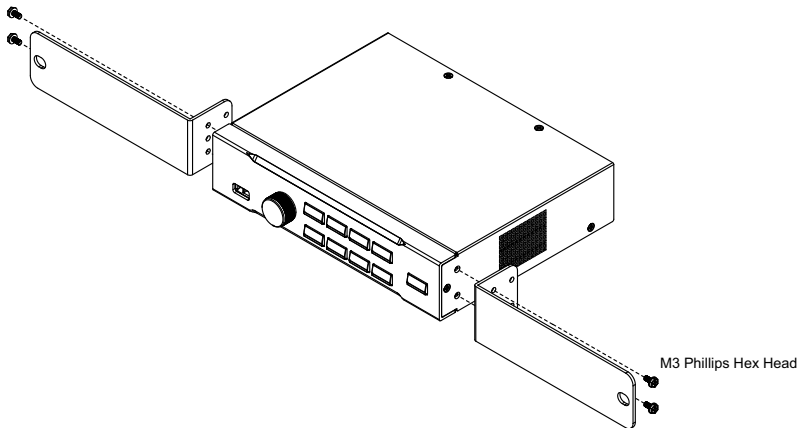

2. Position the unit in the front of the rack and align the holes in the mounting brackets with the holes in the rack.
3. Screw the mounting brackets to the rack.

Under Desk Mount

You can also mount the VP2120 under a desk using the under-desk mounting kit.

Note: The mounting kit required for this installation is not included in the package. For more information on purchasing this accessory, please visit the product web page.

1. Use 4 M3 Phillips hex head screws supplied with the mounting kit to secure the mounting brackets onto the unit.

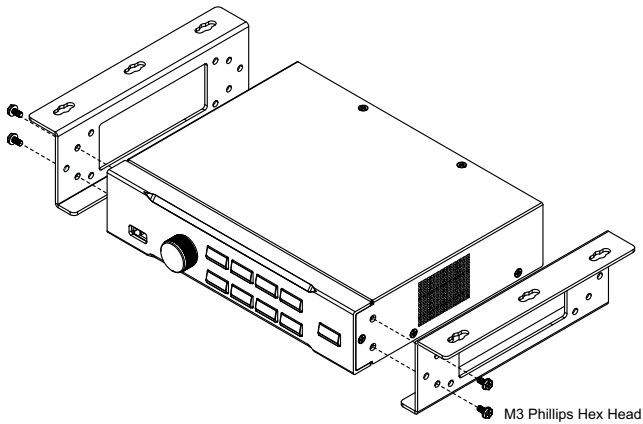

2. Position the unit to a spot under the desk where you can easily access the front-panel pushbuttons, and then secure the racks to the desk with self-prepared screws.

Installation

Follow the steps below to safely install sources, displays, and other equipment to the VP2120.

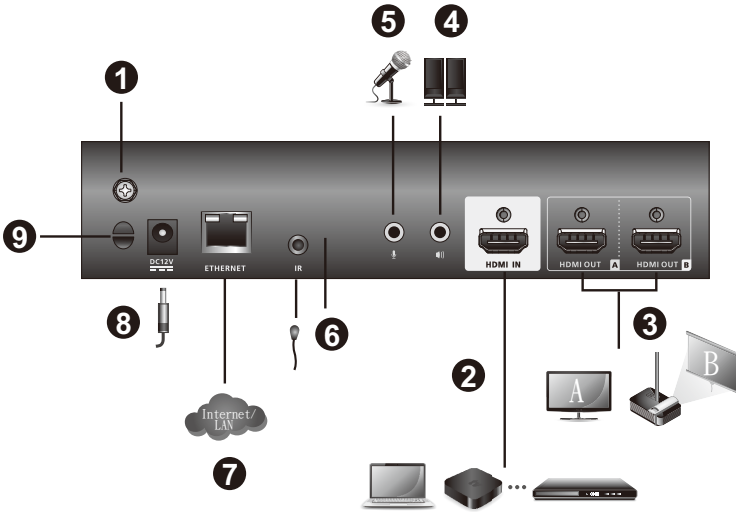

1. Use a grounding wire to ground the unit by connecting one end to the grounding terminal, and the other end to a suitable grounded object.

Note: Do not omit this step. Proper grounding helps prevent damage to the unit from surges or static electricity.

2. Use an HDMI cable to connect an HDMI source to the HDMI In Port.
3. Use an HDMI cable to connect the unit to at least one HDMI-enabled display.

Note: Because the OSD only shows on display A, make sure to connect the display to HDMI Out Port A if you are only using one display.

4. (Optional) Connect an active speaker to the Stereo Audio Out Port.
5. (Optional) Connect a microphone to the MIC In Port.
6. (Optional) To control the VP2120 using an IR remote control, connect the supplied IR Receiver to the IR Receiver Port.

7. (Optional) To allow access to the web interface, use an Ethernet cable to connect the Ethernet Port to a network switch.
8. Plug the power adapter to the Power Jack.
9. (Optional) Use the Cable Tie Slot and a cable tie to hold the power cable in place.
10. Press the Power Pushbutton to power on the VP2120.
11. Power on all the connected devices.

Chapter 3

Local Operation

Overview

This chapter provides detailed information on the features of the VP2120's on-screen display (OSD), and how to locally operate the unit using the front-panel pushbuttons and the IR remote control. You can perform the following tasks through the OSD:

- ◆ Switch display sources
- ◆ Change the display behavior, resolution, or aspect ratio settings
- ◆ Stream out (go live) the displayed content (display A or B) via network connection
- ◆ Configure the VP2120
- ◆ Make screen captures
- ◆ View logs of user actions in the OSD and the web interface
- ◆ Use whiteboard to communicate with meeting participants in real-time

Operation Considerations

- ◆ The IR remote control and the VP2120's front panel offer the same operation capability. Use either method as required.

Note: In this manual, “buttons” is used to refer to the buttons on the IR remote control, and “pushbuttons” is used to refer to the front-panel pushbuttons.

- ◆ Use the IR remote control within the effective range (6 m), and that there is a clear line-of-sight between the remote control unit and the IR receiver connected to the VP2120.
- ◆ When using the ATEN Video Presentation Control App, make sure your mobile device is connected to the same network environment where the VP2120 is installed.

Displaying the Room Info

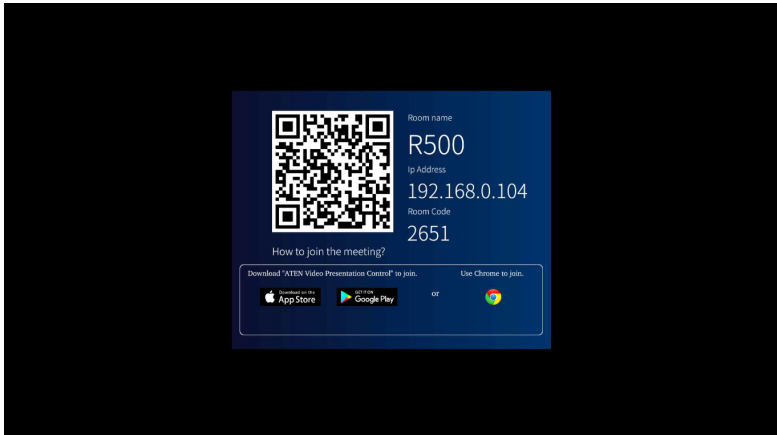

To display meeting information such as the room code, IP address for the web interface, and QR code to join the meeting, use the  **Room Info** pushbutton/button.



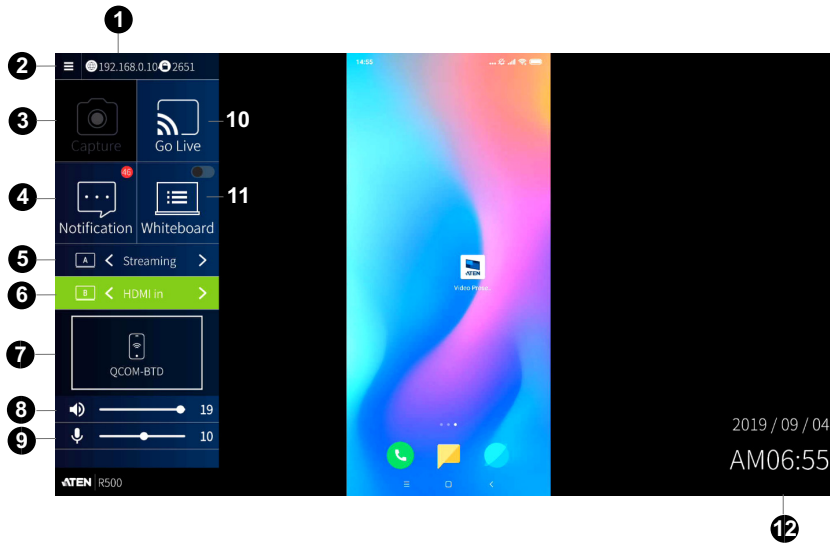

The OSD

- ◆ To launch the OSD, use the **Menu**  pushbutton/button. The OSD menu appears on the display A.
- ◆ To navigate in the OSD, use the **Navigation** pushbuttons/buttons.
- ◆ The following controls are available in the OSD.



No.	Name/Information	Description
1	Connection Information	Displays the IP address of the VP2120's web interface and the room code. Access the web interface to join a remote meeting or remotely configure the VP2120's settings. For details, see Chapter 4, Remote Operation .
2	 Options	Navigate to this icon and press the Enter  pushbutton/button to view or configure VP2120's settings. For details on system settings, see <i>System Settings</i> , page 28.
3	Screen capture	Navigate to this field and then press the Enter  pushbutton/button to capture the screen. The captured image is saved to the storage device connected to the VP2120's USB ports. Make sure you have a storage device inserted to the VP2120 for this function to be available. For more information, see <i>Getting Screen Captures</i> , page 24.

No.	Name/Information	Description
4	Notifications	Navigate to this field and then press the Enter  pushbutton/button to view a record of user actions in the OSD and the web interface, such as users joining a meeting, saving of a screen capture to a connected storage drive, or the screen going live. For more information, see <i>Viewing Event Logs</i> , page 27.
5	Display A	Press the Navigation pushbutton/buttons to switch display source between HDMI source and Streaming source. For more details on the display source, see <i>Switching the Sources</i> , page 17.
6	Display B	Press the Navigation pushbuttons/buttons to switch display source between HDMI source and Streaming source. For more details on the display source, see <i>Switching the Sources</i> , page 17.
7	Streaming Source	Streamed-in devices are shown here. You can enlarge a streamed-in source of your choice when there are multiple streamed-in sources. For more information, see , page 63.
8	Overall Volume	Sets the volume of the speaker connected to the VP2120.
9	Mic Volume	Sets the volume of the microphone connected to the VP2120 by adjusting the output level.
10	Go Live	Navigate to this icon and press the Enter  pushbutton/button to stream out the display. This button grays out if the VP2120 is not connected to network. For more information, see <i>Streaming Out a Display</i> , page 22.
11	Whiteboard	Navigate to this field and then press the Enter  pushbutton/button to bring up the whiteboard on display A. For more information, see <i>Whiteboard</i> , page 25.
12	Date and time	Indicates the system date and time.

Switching the Sources

For each display, you can switch between two channels - the HDMI source and the streamed-in source. The two channels are compared in the table below.

OSD Source List	Description
HDMI source	HDMI source is the source connected to the VP2120's HDMI In Port.
Streaming source	Streaming source 1 ~ 4 are sources that streamed in over the Internet. This channel supports multiview, and streamed-in sources are laid out dynamically to fit in the screen depending on the number of sources available. For more information, see <i>Multiview Display for Streamed-in Sources</i> , page 20.

To switch the source for a display, follow the steps below.

1. Press the **Menu**  pushbutton/button to open the OSD.
2. In the OSD, use the **Navigation** pushbuttons/buttons to locate your target display.

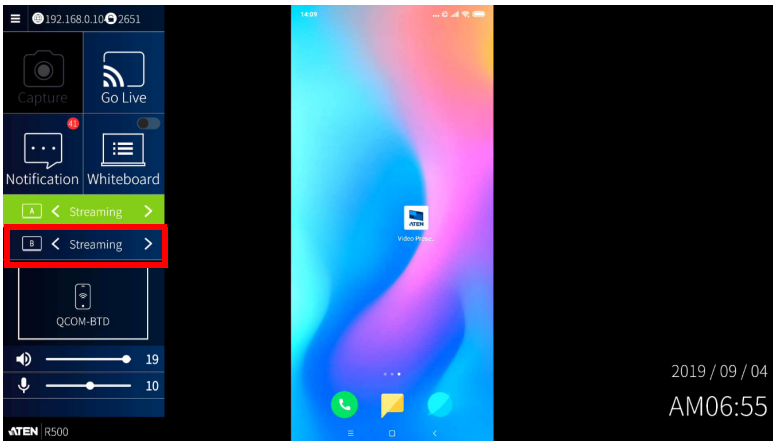

3. Use the left and right **Navigation** pushbuttons/buttons to select the source. In this example, Display B is switched from streamed-in sources to HDMI.

- Now you have successfully switched the display source from streaming to HDMI for display B.

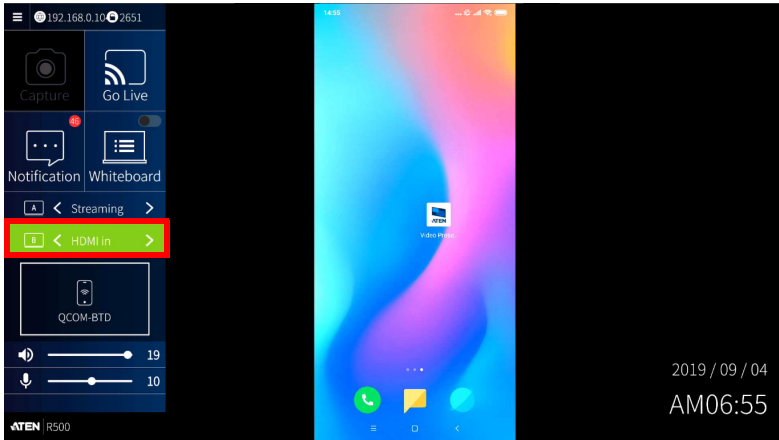

Display Settings and Behavior

Display Mode

By default, the VP2120 can show different sources and keep their own sets of display settings (refer to page 30), including resolution, aspect ratio, and auto switch mode on the two displays:

Matrix Display

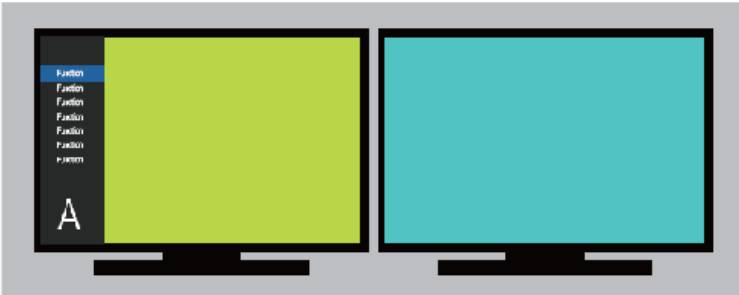

You can also have the connected displays automatically showing identical content using the Mirror Mode feature, which allows display B to automatically follow the source and display settings configured for display A:

Mirror Display

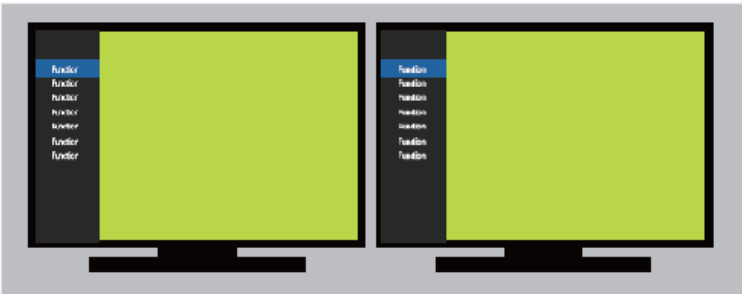

To enable Mirror Mode:

1. Use the Navigation pushbuttons/buttons and go to General > Mirror Mode > Enable.
2. Press the Enter pushbutton/button. Display B immediately switches to the source assigned for display A.

Multiview Display for Streamed-in Sources

The VP2120 supports multiview display for streamed-in sources. This display mode is automatically enabled when a display is set to **Streaming**, and that 2, 3, or 4 video sources are shared to the Presentation Switch.

Note: In a multiview, shared sources display in predefined locations based on the order at which the source is shared. As sources are received by the Presentation Switch, they appear on the display from left to right, top to bottom.

- ◆ One source

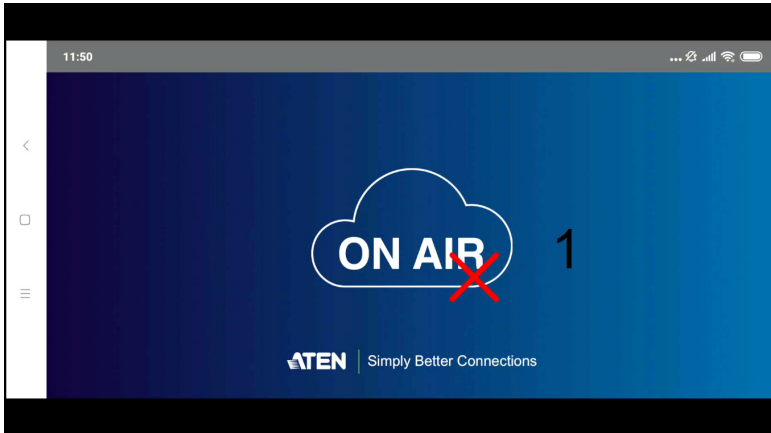

- ◆ Two sources

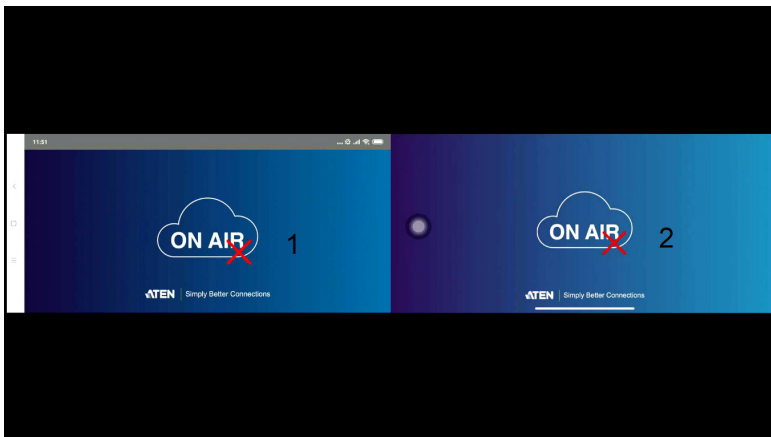

◆ Three sources

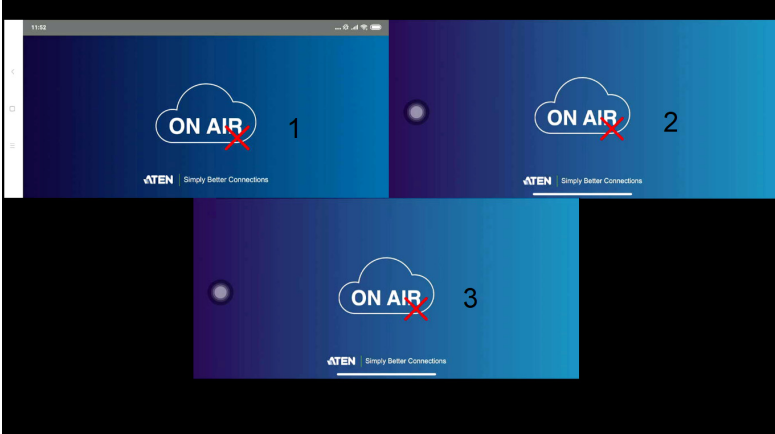

◆ Four sources

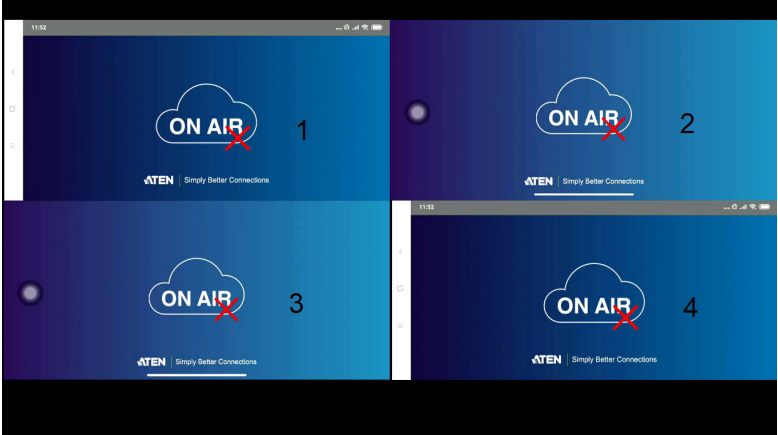

Streaming Out a Display

Overview

There are two ways to broadcast the content on one of the displays at a time to meeting participants. You can use the IR remote control or the OSD via the front-panel pushbuttons.

Note: Make sure that the VP2120 is connected to the network and reserve at least 3 MB of network bandwidth for smooth streaming.

Using the IR Remote Control

To start broadcasting, use the  buttons to select display A or display B to stream out.





Using the OSD

To start broadcasting, follow the steps below.

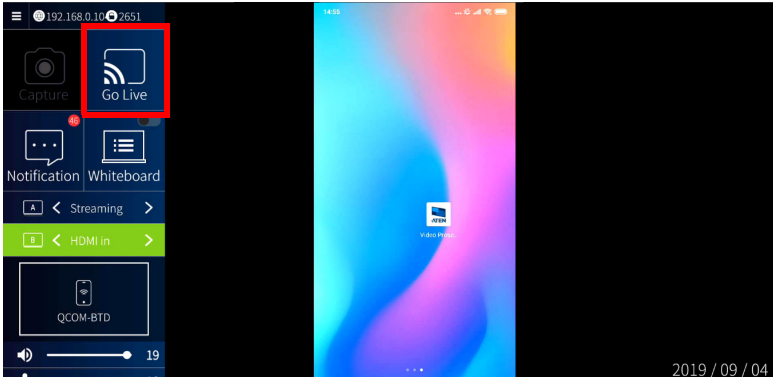
1. Press the **Menu**  pushbutton/button to open the OSD.
2. In the OSD, locate the **Go Live** icon using the **Navigation** pushbuttons/buttons.



3. Press the **Enter**  pushbutton/button to select a display to stream out and press the **Enter**  again.
4. The display of your choice is now streamed out. A live icon appears on the top-right of your chosen display, reminding you which display is being streamed out.

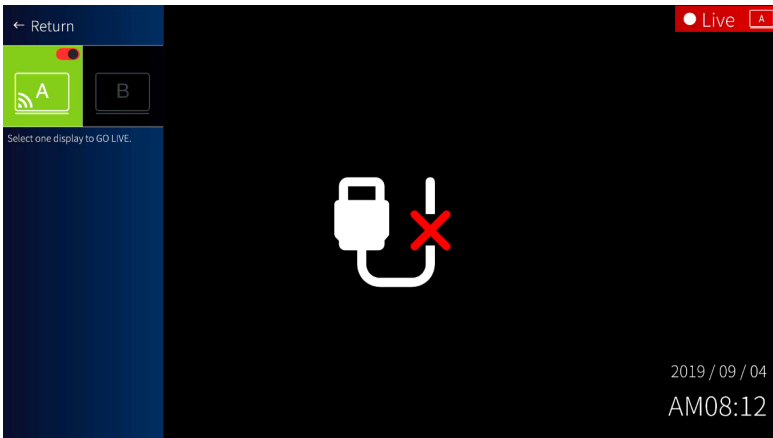



Getting Screen Captures

You can capture and save important screens during a meeting using the Capture function.

Note: The USB storage device must be in format FAT to be recognized by the VP2120.

To capture a screen, follow the steps below.

1. Insert a USB storage device to the VP2120 for this function to be available.
2. Press the **Menu**  pushbutton/button to open the OSD.
3. In the OSD, locate the **Capture** icon using the **Navigation** pushbuttons/buttons.
4. Press the **Enter**  pushbutton/button. The screen is captured and saved to the storage device.

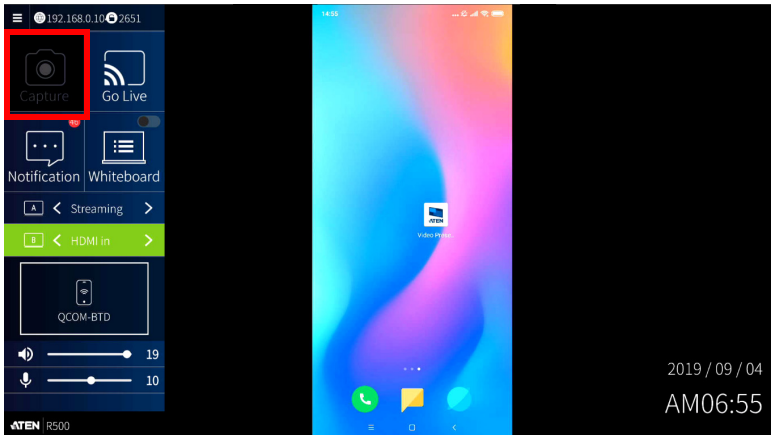

Whiteboard

The whiteboard allows you to draw, insert images, create texts, and share to all the participants and administrator. You can also save the whiteboard locally for future use. For more information, see , page 63.

Use the IR remote control or the front-panel pushbuttons to open the whiteboard.

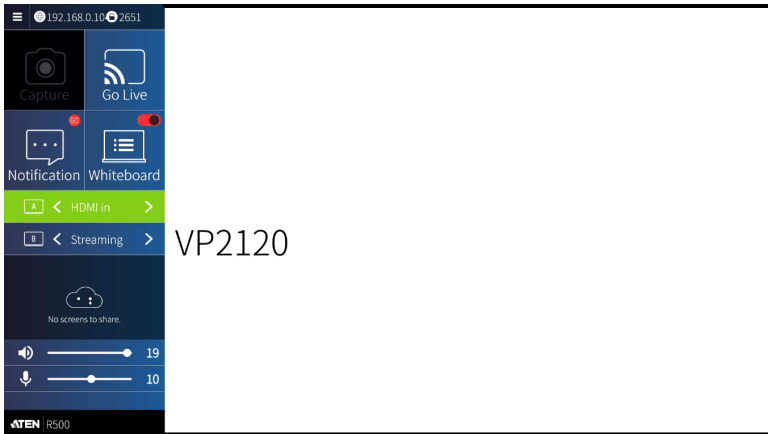

Note: The whiteboard can only be displayed on display A. For more information on whiteboard, see , page 63.



Using the IR Remote Control

To launch the whiteboard, use the **Whiteboard**  button. The whiteboard opens on display A.

Using the OSD

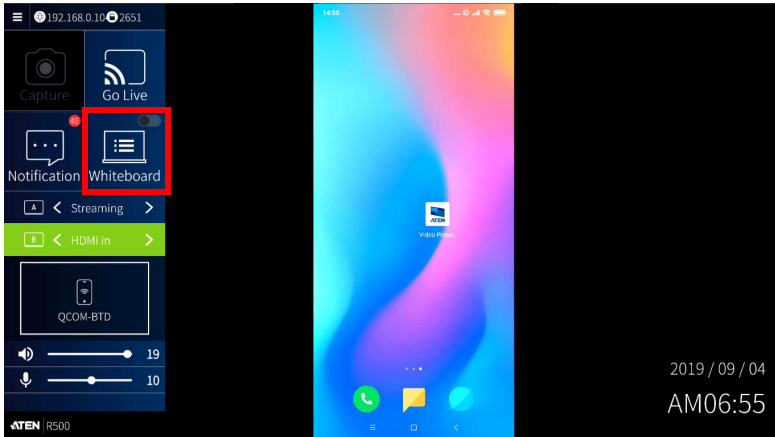

1. Press the **Menu**  pushbutton/button to open the OSD.
2. In the OSD, locate the **Whiteboard** icon using the **Navigation** pushbuttons/buttons.
3. Press the **Enter**  pushbutton/button.





Viewing Event Logs

The VP2120 logs user actions performed via the OSD and the web interface, such as users joining a meeting, saving of a screen capture to a connected storage device, or a screen going live.

To view these events, follow the steps below.

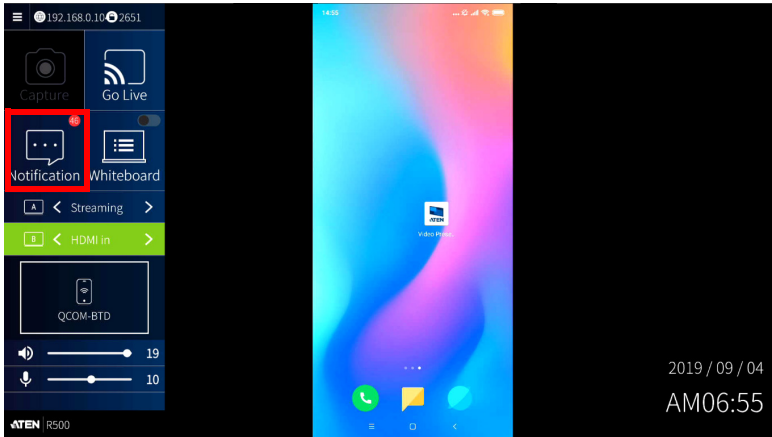

1. Press the **Menu**  pushbutton/button to open the OSD.
2. In the OSD, locate the **Notification** icon using the **Navigation** pushbuttons/buttons, and press the **Enter**  pushbutton/button.

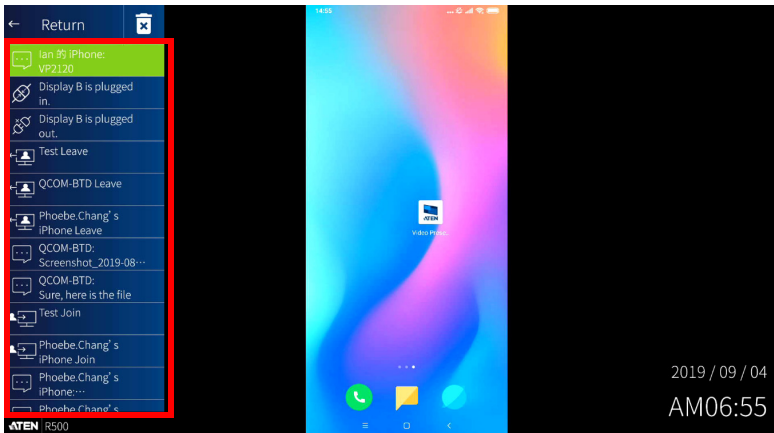

3. Event logs are displayed on the OSD, press  icon to delete event logs.





Locking the Front Panel

To lock the front-panel pushbuttons, press and hold the **Up** Navigation pushbutton for 5 seconds until the lock icon  lights red. To unlock, press and hold the **Up** navigation pushbutton for 5 seconds, until the lock icon  dims.

System Settings

To access system settings:

1. Press the **Menu**  pushbutton/button to launch the OSD on display A.
2. In the OSD, navigate to  and then Press the **Enter**  pushbutton/button, this screen appears.

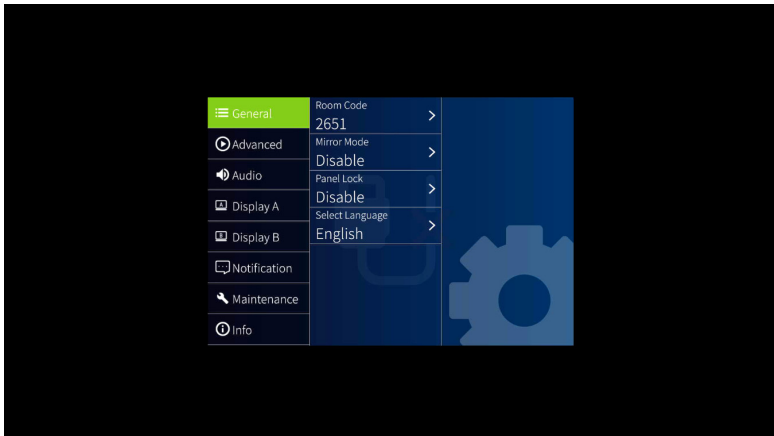

3. Configure the system settings as required. Refer to the following tables for details of each setting.

System Settings			Description
Note: Default settings are indicated in bold.			
General	Room Code	<ul style="list-style-type: none"> ◆ Disable ◆ Refresh code 	Enables and generates a random room code to be required for joining a meeting.
	Mirror Mode	<ul style="list-style-type: none"> ◆ Enable ◆ Disable 	Each connected display mirrors each other and does not take different settings. Click the check-box to enable, configuration on display A is automatically applied to the display B. For details, see <i>Display Mode</i> , page 19.
	Panel Lock	<ul style="list-style-type: none"> ◆ Disable ◆ 5 sec later ◆ 30 sec later ◆ 5 min later 	Automatically locks the front-panel pushbuttons if the OSD idles for the selected duration.
	Select Language		Sets the display language of the OSD.
Advanced	EDID Mode	<ul style="list-style-type: none"> ◆ ATEN Default ◆ Display A 	<ul style="list-style-type: none"> ◆ ATEN default: This mode sends ATEN-predefined EDID to the connected sources. ◆ Display A: This mode sends the EDID of Display A to the connected sources.
	HDCP Mode	<ul style="list-style-type: none"> ◆ None HDCP ◆ HDCP 	Enables this function to prevent copying of the audio and video content as it travels across connections.

System Settings		Description	
Note: Default settings are indicated in bold.			
Audio	Overall Volume	<ul style="list-style-type: none"> ◆ Increase (+) ◆ Decrease (-) ◆ Mute 	Sets the volume of the speaker connected to the VP2120.
	Mic Volume	<ul style="list-style-type: none"> ◆ Increase (+) ◆ Decrease (-) ◆ Mute 	Sets the volume of the microphone connected to the VP2120 by adjusting the output level.
	Streaming Volume	<ul style="list-style-type: none"> ◆ Increase (+) ◆ Decrease (-) ◆ Mute 	Sets the volume of the streamed-in source.
	Media Volume	<ul style="list-style-type: none"> ◆ Increase (+) ◆ Decrease (-) ◆ Mute 	Sets the volume of connected sources.
Display A	Channel	<ul style="list-style-type: none"> ◆ HDMI ◆ Streaming 	Switches source between HDMI and Streaming for display A. For more information, see <i>Switching the Sources</i> , page 17.
	Resolution		Select a resolution and refresh rate setting for display A. This field is only available when the display is connected to the VP2120.
	Aspect Ratio	<ul style="list-style-type: none"> ◆ Scale to Whole ◆ Auto Fit ◆ Auto Cut 	<ul style="list-style-type: none"> ◆ Scale to Whole: Fully extends the video to the four sides of the display. ◆ Auto Fit: Proportionally scales the video to fit the display without cutting any content off. This may leave some blank on either the top and bottom or the left and right of the screen. ◆ Auto Cut: Proportionally scales the video to fully fill the display. The content that goes out of the display range will be cut off.
	Auto Switching	<ul style="list-style-type: none"> ◆ Enable ◆ Disable 	Automatically switches to a newly detected source.

System Settings			Description
Note: Default settings are indicated in bold.			
Display B	Channel	<ul style="list-style-type: none"> ◆ HDMI ◆ Streaming 	Switches source between HDMI and Streaming for display B. For more information, see <i>Switching the Sources</i> , page 17.
	Resolution		Select a resolution and refresh rate setting for display B. This field is only available when the display is connected to the VP2120.
	Aspect Ratio	<ul style="list-style-type: none"> ◆ Scale to Whole ◆ Auto Fit ◆ Auto Cut 	<ul style="list-style-type: none"> ◆ Scale to Whole: Fully extends the video to the four sides of the display. ◆ Auto Fit: Proportionally scales the video to fit the display without cutting any content off. This may leave some blank on either the top and bottom or the left and right of the screen. ◆ Auto Cut: Proportionally scales the video to fully fill the display. The content that goes out of the display range will be cut off.
	Auto Switching	<ul style="list-style-type: none"> ◆ Enable ◆ Disable 	Automatically switches to a newly detected source.
Notifications	Display Time	<ul style="list-style-type: none"> ◆ 3 sec ◆ 5 sec ◆ 10 sec ◆ Disable 	Disable or sets the duration for which a notification message pops up in the OSD.
	Web Event	<ul style="list-style-type: none"> ◆ Disable ◆ Enable 	Displays notifications on user actions performed via the web interface.
	System Event	<ul style="list-style-type: none"> ◆ Disable ◆ Enable 	Displays notifications on system status, device connection status, and user actions performed via the OSD.

System Settings		Description
Note: Default settings are indicated in bold.		
Maintenance	FW Upgrades	Upgrades the VP2120's system firmware. Note: Save the firmware file to a USB drive and plug it into the VP2120 before the upgrade.
	Reset to Default	Sets the VP2120 to its default settings.
Info	Vender, firmware version, serial number, hardware version, build version	Displays the system information.

Chapter 4

Remote Operation

Overview

This chapter provides information on remote operation of the VP2120 - the web interface and the ATEN Video Presentation Control App. The information is organized based on account type and control interface (web interface or ATEN Video Presentation Control App).

The VP2120's IP Address

When the VP2120 connects to the network for the first time, it is assigned a dynamic IP address or uses a default IP address if the network switch does not support DHCP.

- ◆ The default IP address and other network settings are as follows:

Network Parameter	Settings
IP Address	192.168.0.60
Subnet Mask	255.255.255.0
Gateway	192.168.0.1
HTTP Port	80

- ◆ To look up the VP2120's IP address, press  on the remote control or front panel pushbutton to launch the OSD. The IP address is indicated in the OSD. For more information on the room info, see page 15.

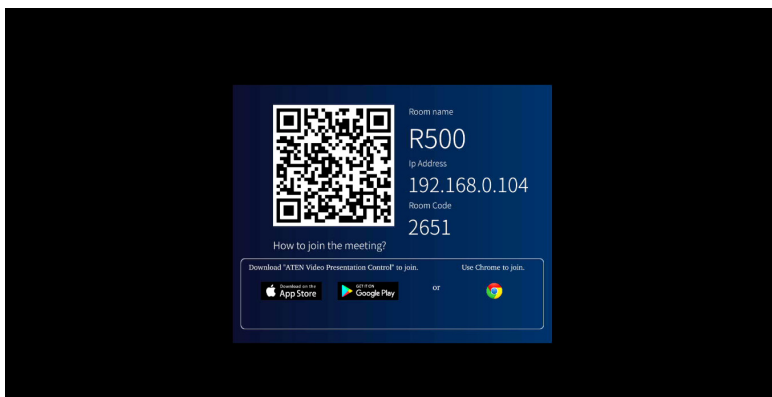

Account Types and Privileges

The web interface allows both administrator and participant logins, and ATEN Video Presentation Control App only allows participant logins. The administrator account differs from a participant account in that it has access to the VP2120 system configuration.

Privileges	Administrator	Participant
Join online meetings and share content	✓	✓
Configure the basic VP2120's settings	✓	✓
Configure administrator settings	✓	x
Back up and restore VP2120's settings	✓	x
Maximum number of logins	No limit	4
Control Interface	Web interface	<ul style="list-style-type: none"> ◆ Web interface ◆ ATEN Video Presentation Control App

Note: The total number of logins includes those made from the web interface and the App.

Supported Web Browsers

The VP2120 supports access to its web UI through the following web browsers and operating systems:

Web Browser	Supported Version	Operating System
Chrome	64.0.3282.168	Windows 10
	60.0.3112.113	Windows 10
	64.0.3282.167	Ubuntu 16.04
	60.0.3112.78	Ubuntu 16.04
Firefox	58.0.2	Windows 10
	54.0.1	Windows 10
	58.0.2	CentOS 7.0
	52.4.0	CentOS 7.0

Note: The streaming-in function (Sharing button) is not supported by Firefox due to compatibility. Only use Chrome if you need to share your contents through VP2120.

The Administrator Account

When you log into the VP2120's web interface as administrator, you are connected to an online meeting and have access to the VP2120's settings.

Logging in as Administrator

1. In a web browser, type the web link (IP address) of the VP2120. This screen appears.

Note: Find the VP2120's web link from the OSD. For more information, see *The VP2120's IP Address*, page 35.

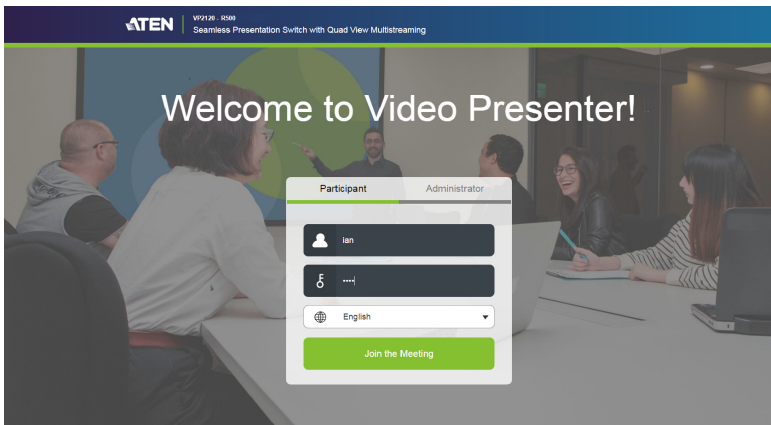

2. Click the **Administrator** tab. This screen appears.

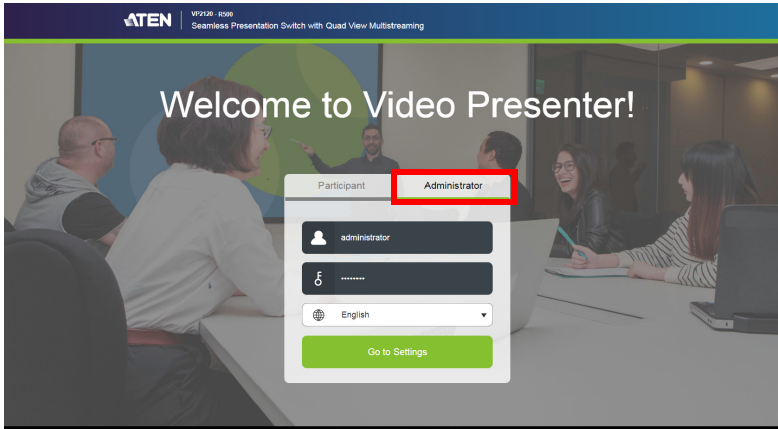

3. Type the administrator's username and password. The default username is **administrator** and the password is **password**.

Note: ATEN suggests changing your password upon first login. To change the password, go to **General > Change Password** in the web interface.

4. Click **Go to Settings**. The main screen appears.

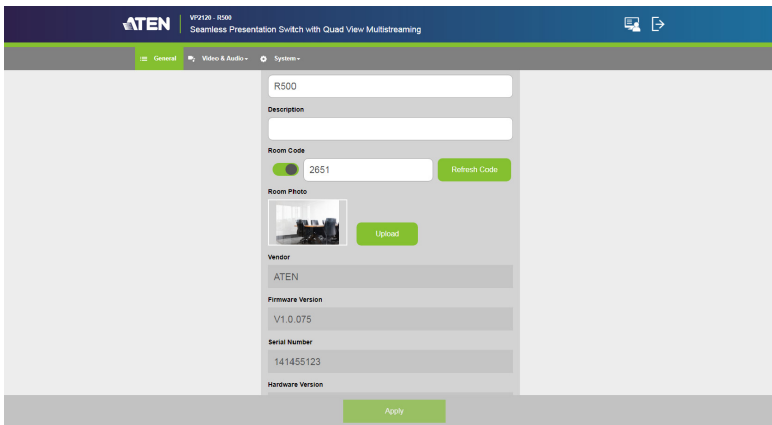



The Administrator Screen

When logged in as administrator, the configuration view appears.

Configuration View

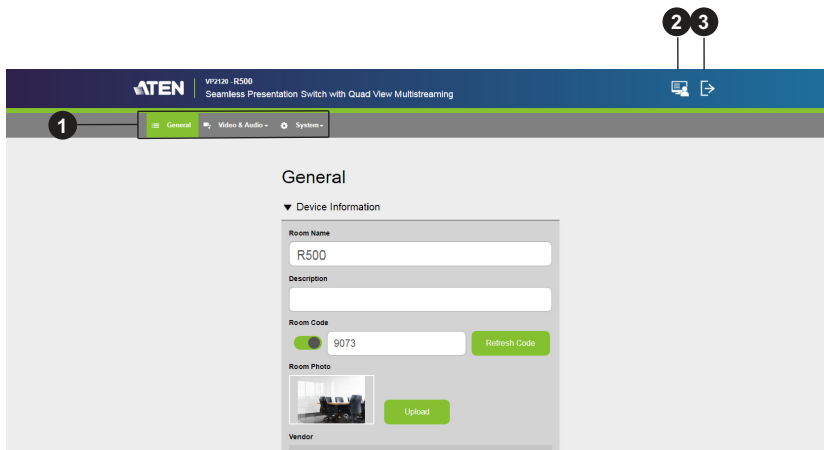
Use the Configuration View to access system settings. To go to the Configuration View, log in the web interface as administrator.



No.	Control	Description
1	Settings Tabs	Use these tabs to access system settings. For details, see <i>System Configuration</i> , page 52.
2	Go to Presentations 	Click this button go to the presentation view to join online meetings.
3	Log Out 	Click this button to log out the VP2120's web interface.

Tip: Click the ATEN logo at the top-left corner to visit ATEN's official website.

Presentation View





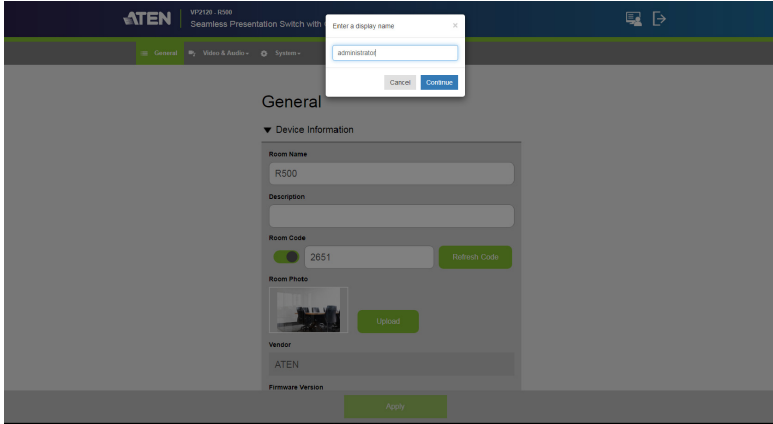

Use the Presentation View to participate online meetings. To access the Presentation View, log in the web interface as administrator and click the **Go to Presentation**  icon in the toolbar.

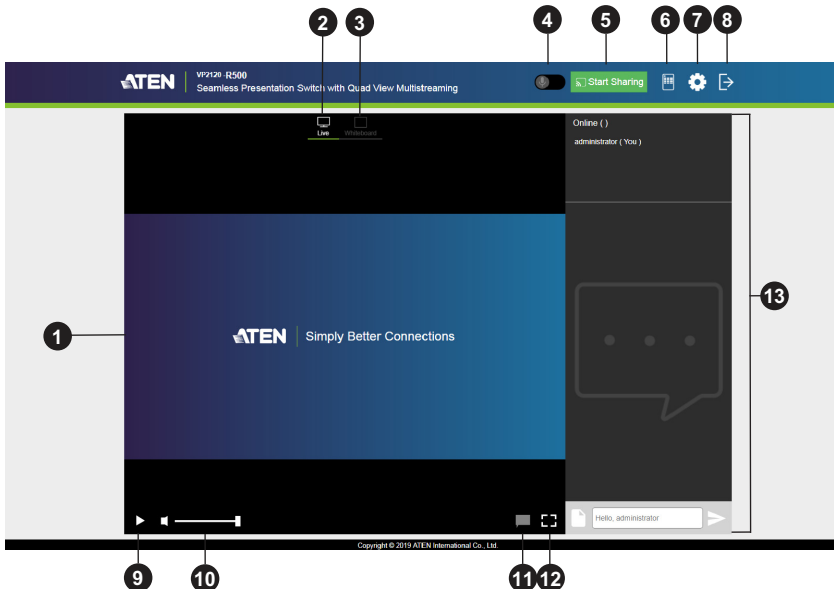
You will be asked to enter a display name:



Type a display name and click **Continue**. The Presentation View appears.



No.	Control	Description
1	Live Screen	Displays the content that goes live from the VP2120.
2	Live	When the Live icon  appears, your Live Screen is showing a live streaming.
3	Whiteboard	When the whiteboard icon  appears, your Live Screen is showing the Whiteboard. For more information, see <i>Whiteboard</i> , page 43.
4	Microphone 	Click to speak to the meeting members. Make sure your microphone is plugged into the VP2120 for this function to be available.
5		Click to share a screen, an application window, or a Chrome tab from you PC or laptop to the VP2120 and makes it available for broadcast to all meeting participants. For details, see <i>Sharing a Screen or an Application Window</i> , page 42.
6	Control Panel 	Click to access to the basic VP2120 settings. For more information, see , page 46. System settings such as maintenance, network settings, and general settings are not located in the control panel.
7	Go to Configuration 	Click this button to go to the Configuration View. For details about the Configuration View, see <i>Configuration View</i> , page 39.
8	Log Out 	Click this button to log out the VP2120's web interface.
9	Play / Pause	Click this button to play or pause the live streaming contents.
10	Volume Control	Allows you to tune the volume and click on the icon to mute.
11	Disable Chat Panel	Removes the chat room to make the display bigger.
12	Full Screen	Extends the display to full screen.
13	Chat Panel	Use this panel to instantly message and interact with other meeting participants.

Tip: Click the ATEN logo at the top-left corner to visit ATEN's official website.

Sharing a Screen or an Application Window

You can share your laptop/PC screen, or an application window/Chrome tab from your laptop/PC.

Note:

- ◆ This feature is only available using Chrome.
 - ◆ The VP2120 can receive up to 4 concurrent streamed-in channels.
-

1. Make sure you have the screen, application window, or the Chrome tab you wish to share opened on your PC/desktop.
2. Log into the VP2120's web interface as participant.
3. From the participant's screen, click **Start Sharing**. This screen appears.

Share your screen

192.168.0.101 wants to share the contents of your screen. Choose what you'd like to share.

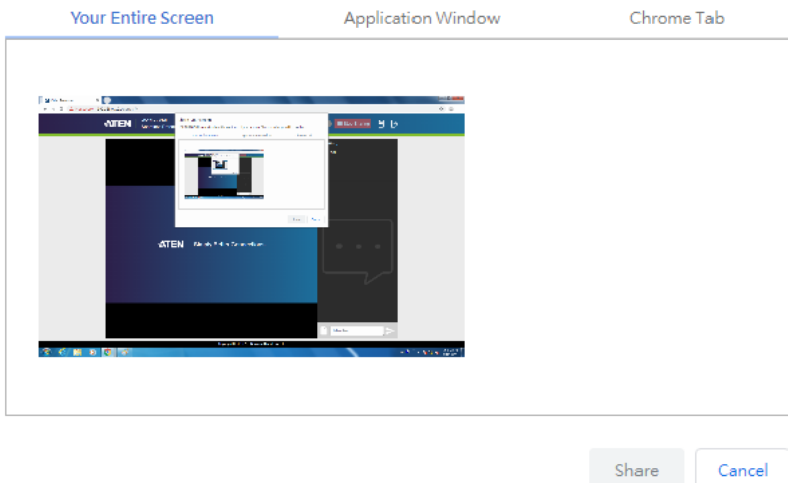

Note:

If your Chrome does not have an appropriate extension installed for this feature, a prompt appears for installing an extension when you try to enable the function. In this case, follow the steps below to download and install the extension.

- a. Click **download** in the pop-up prompt.
 - b. Open a new tab in your Chrome and type **chrome://extensions** in the address bar to open the extensions page.
 - c. Enable **Developer mode** at the top-right corner and reload the page.
 - d. Drag-and-drop the downloaded extension file to this page to install the file.
 - e. Close and reopen the tab to refresh your browser.
-

4. Select an option and click **Share**. The VP2120 is now sharing the selected content.

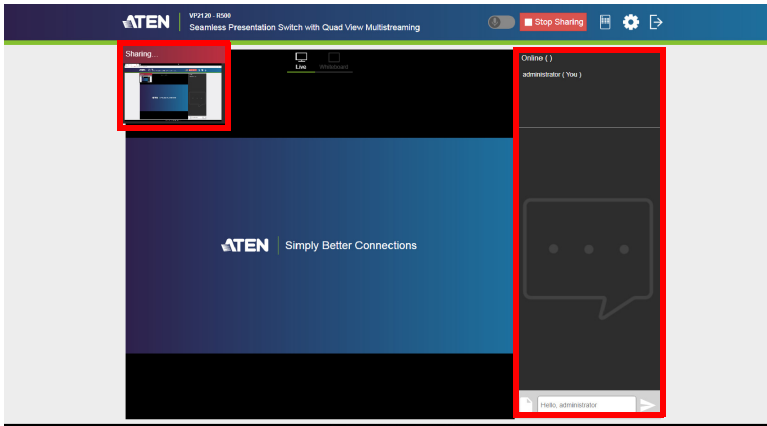

5. To remind the host and participants that you have shared your content, you can:
 - ◆ Send another notification to the VP2120 by clicking the Queuing window.
 - ◆ Send a text message using the chat panel.

Note:

- ◆ When sharing an application window, keep it open to allow sharing. Minimizing the window terminates the sharing.
 - ◆ To speak during the meeting from your PC/laptop, unplug the audio output wire from your speaker and replug it into the microphone input port on your PC/laptop.
 - ◆ Make sure to set at least one display to streaming for the source to show. For more information, see *Switching the Sources*, page 17.
-

Whiteboard

The whiteboard allows you to draw, insert images, or create texts and share to all the participants and administrator. You can also save the sketches locally for future use.

To enable the whiteboard, click **Whiteboard** from the presentation view. This screen appears.

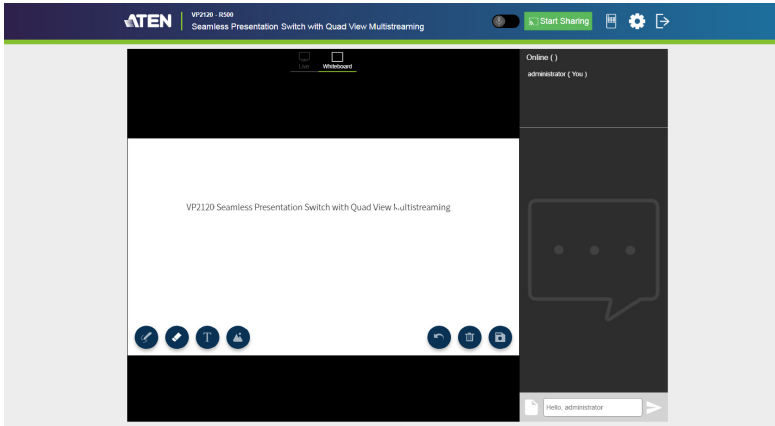

Each tools and its purpose are described below.

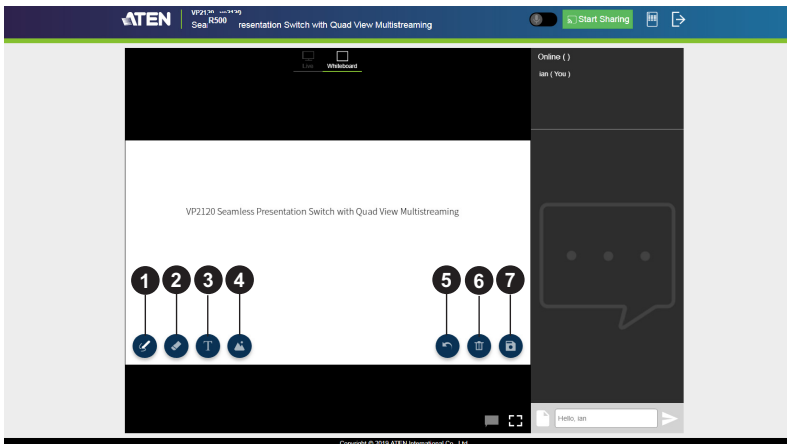





No.	Tool	Description
1	Pencil	Click to select a color and size for the pencil to write or draw on the whiteboard.
2	Eraser	Click to select a size for the eraser to remove any pixels on the whiteboard.
3	Text	Click to insert and select a color for the text. For detailed steps, see <i>How to Insert Text</i> , page 45.
4	Image	Click to browse and insert an image on the whiteboard.
5	Undo	Click to undo your current move.
6	Bin	Click to remove the current whiteboard to the bin. A warning message appears, click cancel or continue to remove the whiteboard.
7	Save	Click to automatically save your current whiteboard in your local computer/desktop.

How to Insert Text

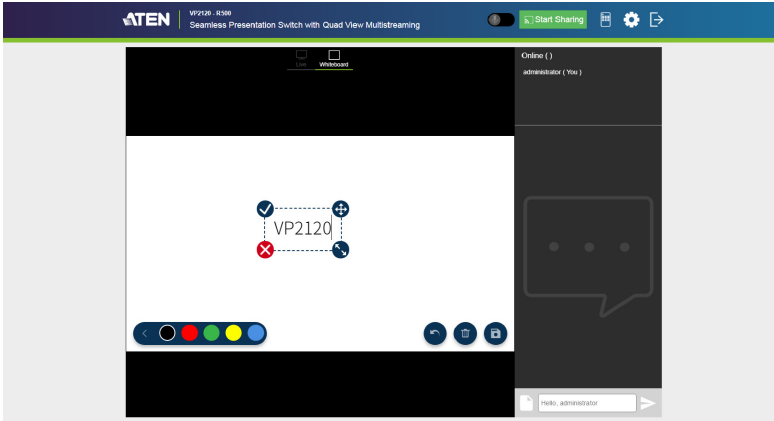
To insert a text in the whiteboard, follow the steps below.

1. Click the text tool to select a color for the text.
2. Left click anywhere on the whiteboard to insert a text.



No.	Tool	Description
1		Click to accept and the current text will be entered on the whitboard.
2		Click to drag the current text to a position that you like.
3		Click and drag to resize the current text.
4		Click to remove the current text.

Control Panel

You can adjust audio, video, and general settings of the VP2120. To access these settings, click the control panel icon  from the presentation view. The control panel opens.

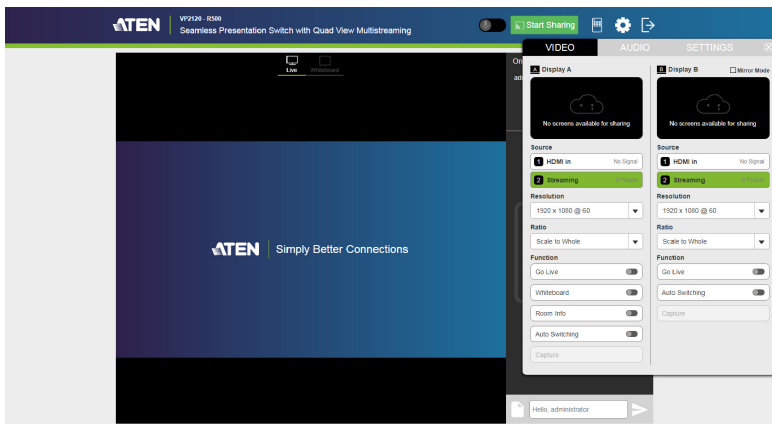

Video

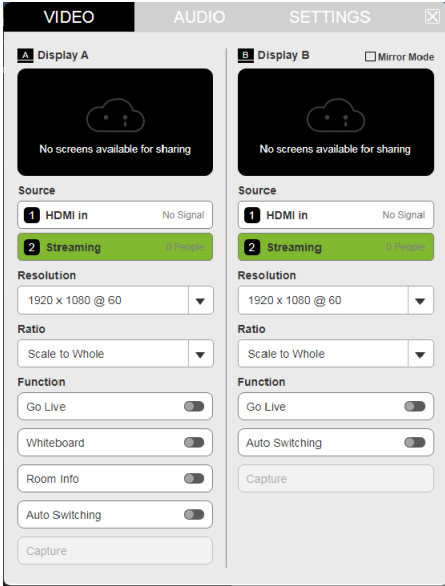



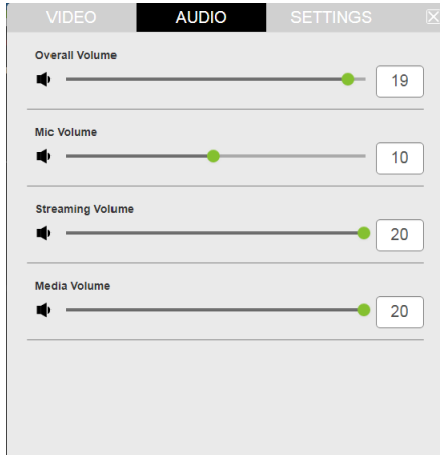

Video Settings		Description
A	Display A	Shows a preview of the selected source.
B	Display B	Shows a preview of the selected source.
	Mirror Mode	Each connected display mirrors each other and does not take different settings. Tick the checkbox to enable, configuration on display A is automatically applied to the display B.
Source	HDMI	Selects the HDMI source to be displayed on display A or B.
	Streaming	Selects the Streaming source to be displayed on display A or B.
Resolution		Click the drop-down list to select a resolution and refresh rate setting for the display device. This field is only available when the display is connected to the VP2120.

Video Settings		Description
Ratio	Scale to Whole	Fully extends the video to the four sides of the display.
	Auto Fit	Proportionally scales the video to fit the display without cutting any content off. This may leave some blank on either the top and bottom or the left and right of the screen.
	Auto Cut	Proportionally scales the video to fully fill the display. The content that goes out of the display range will be cut off.
Function	Go Live	Enables go live for the display A or B.
	Whiteboard	Enables whiteboard on display A. Note: Whiteboard can only be displayed on display A.
	Room Info	Enables room info on display A. Note: Room info can only be displayed on display A.
	Auto Switching	Automatically switches to a newly detected source.
	Capture	Captures the screen image and save it to the storage device connected to the VP2120's USB ports. Make sure you have a storage device inserted to the VP2120 for this function to be available.

Audio



Audio Settings	Description
Overall Volume	Sets the volume of the speaker connected to the VP2120 and press  to mute.
Mic Volume	Sets the volume of the microphone connected to the VP2120 and press  to mute.
Streaming Volume	Sets the volume of the streamed-in source and press  to mute.
Media Volume	Sets the volume of connected sources and press  to mute.

Settings

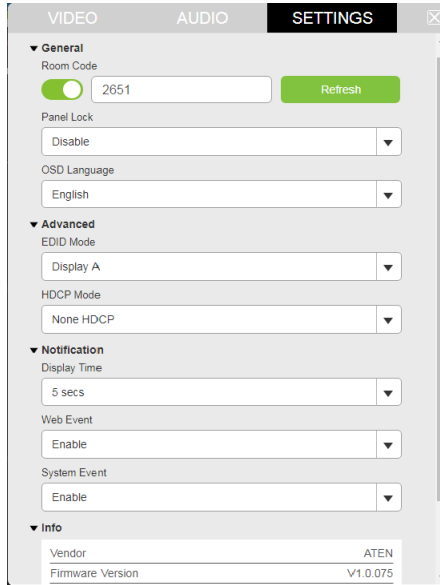

Settings		Description
General	Room Code	Enables a room code that is a-digit combination that is required for logging in the VP2120 web interface and joining an online meeting. You can type your own combination or click Refresh to generate a random number.
	Panel Lock <ul style="list-style-type: none"> ◆ Disable ◆ 5 sec later ◆ 30 sec later ◆ 5 min later 	Automatically locks the front panel pushbuttons if the OSD idles for the selected duration.
	OSD Language	Use the drop-down list to set the language of the OSD.

Settings		Description
Advanced	EDID Mode <ul style="list-style-type: none"> ◆ ATEN Default ◆ Display A 	<ul style="list-style-type: none"> ◆ ATEN Default: This mode sends ATEN-predefined EDID to the connected sources. ◆ Display A: This mode sends the EDID of Display A to the connected sources.
	HDCP Mode <ul style="list-style-type: none"> ◆ None HDCP ◆ HDCP 	Enables this function to prevent copying of the audio and video content as it travels across connections.
Notification	Display Time <ul style="list-style-type: none"> ◆ Disable ◆ 3 sec ◆ 5 sec ◆ 10 sec 	Disable or sets the duration for which a notification message pops up in the OSD.
	Web Event <ul style="list-style-type: none"> ◆ Enable ◆ Disable 	Displays notifications on user actions performed via the web interface.
	System Event <ul style="list-style-type: none"> ◆ Enable ◆ Disable 	Displays notifications on system status, device connection status, and user actions performed via the OSD.
Info	Vendor, Firmware Version, Serial Number, Hardware Version, Build Version	Displays the system information.

System Configuration

General Settings

General settings include settings for device name, system date and time, and login credentials. To access the general settings page, log in the web interface as administrator, and then click the **General** tab.

General

▼ Device Information

Room Name

Description

Room Code

Room Photo

Vendor
ATEN

Firmware Version
V1.0.075

Serial Number
141455123

Hardware Version
A-02

Build Version
19072606

▼ Date / Time

Device Time
2019-10-25 05:41:14

Time Zone

◦ NTP Server ◦ Manual Settings
2019-10-25 05:41:14

▼ Change Password

Password

Confirm Password

▼ Advanced

EDID Mode

HDCP Mode

◆ Device Information

- ◆ **Room Name:** Type a name for the VP2120. This name appears on the top of the VP2120's web interface.

The screenshot shows the 'System' configuration page for the VP2120. At the top, the device name 'VP2120 R500' is displayed. The main configuration area includes:

- Room Name:** A text input field containing 'R500', highlighted with a red box.
- Description:** An empty text input field.
- Room Code:** A section with a toggle switch (currently off), a text input field containing '2651', and a green 'Refresh Code' button.
- Room Photo:** A section with a placeholder image and a green 'Upload' button.
- Vendor:** A text field displaying 'ATEN'.

- ◆ **Description:** Type a description to describe the meeting.
 - ◆ **Room Code:** A room code is a 4-digit combination that is required for logging in the VP2120's web interface and joining an online meeting. You can type your own combination or click **Refresh Code** to generate a random number.
 - ◆ **Room Photo:** You can upload an image to represent the meeting.
 - ◆ **Vendor, Firmware Version, Serial Number, Hardware Version, Build Version:** Indicate device information of the VP2120.
- ◆ **Date / Time**

Note: When any date/time setting is changed, the VP2120 will refresh itself and the connection to the streamed-in channel (Source 6) will be automatically closed.

- ◆ **Device Time:** Displays the current device date and time.
- ◆ **Time Zone:** Use the drop-down list to select a time zone.
- ◆ **NTP Server:** Select this option to synchronize the VP2120's date and time with the NTP server.
- ◆ **Manual Setting:** Select this option to manually set the VP2120's date and time. Click the indicated field to open the calendar and select a date.

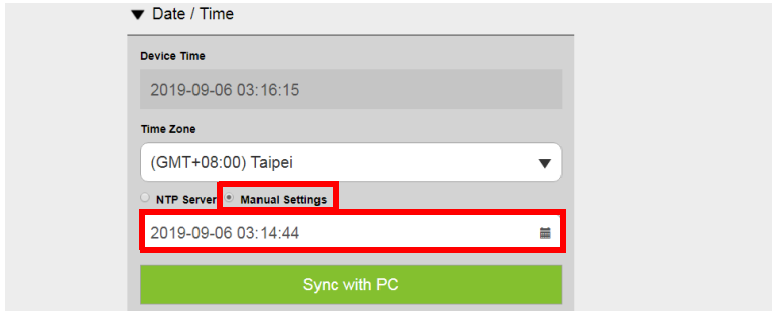

◆ Click  to set the time.

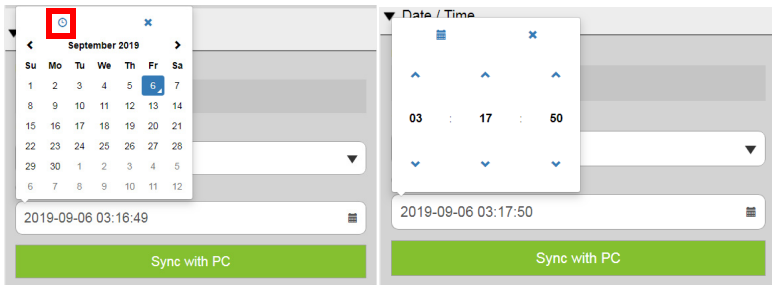



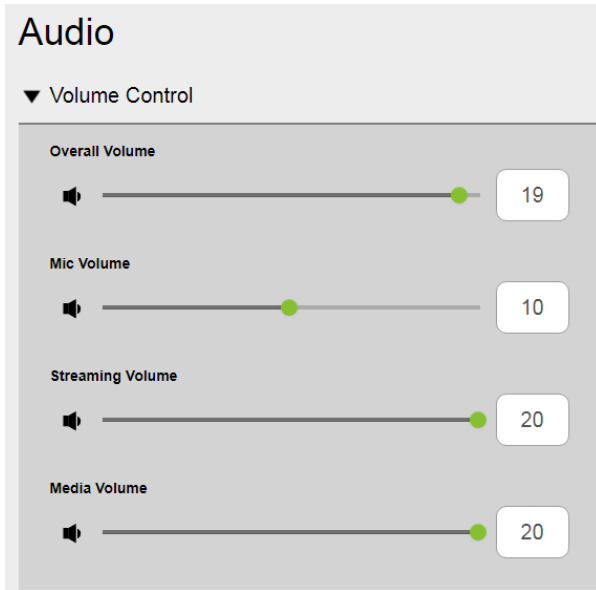

- ◆ **Sync with PC:** Click this button to synchronize the VP2120's date and time with the PC with which the web interface is opened.
- ◆ **Change Password**
Use these fields to change the login password.
- ◆ **Advanced**
 - ◆ **EDID Mode:**
 - ◆ **ATEN Default:** This mode sends ATEN-predefined EDID to the connected sources.
 - ◆ **Display A:** This mode sends the EDID of Display A to the connected sources.
 - ◆ **HDCP Mode:** Enables **None HDCP** or **HDCP** to prevent copying of the audio and video content as it travels across connections.

Audio Settings

To access the audio settings, log in the web interface as administrator, and then go to **Video & Audio > Audio**.



- ◆ **Volume Control:** Adjust the volume settings by dragging the sliders or change the volume values.
 - ◆ **Overall volume:** Sets the volume of the speaker connected to the VP2120 and press  to mute.
 - ◆ **Mic volume:** Sets the volume of the microphone connected to the VP2120 and press  to mute.
 - ◆ **Streaming volume:** Sets the volume of the streamed-in source and press  to mute.
 - ◆ **Media volume:** Sets the volume of connected source and press  to mute.

Display Settings

To access the display settings, log in the web interface as administrator, and then go to **Video & Audio > Display**.

Display

▼ Basic

Mirror Mode

Disable ▼

▼ Display A

Display source

Streaming ▼

Ratio

Scale to Whole ▼

Resolution

1920 x 1080 @ 60 ▼

Auto switching

Disable ▼

▼ Display B

Display source

Streaming ▼

Ratio

Scale to Whole ▼

Resolution

1920 x 1080 @ 60 ▼

Auto switching

Disable ▼

▼ OSD Notification

Display Time

5 secs ▼

Web Event

Enable ▼

System Event

Enable ▼

- ◆ **Basic (Mode):**
 - ◆ **Mirror mode:** Each connected display mirrors each other and does not take different settings. In this mode, configuration on one display is automatically applied to other displays connected to the VP2120.
 - ◆ **Display A:** Sets the display source, ratio, resolution, and auto switching for the connected display devices.
 - ◆ **Display Source:** Click the drop-down menu to select display source between HDMI and Streaming.
 - ◆ **Ratio:**
 - ◆ **Scale to whole:** Fully extends the video to the four sides of the display.
 - ◆ **Auto fit:** Proportionally scales the video to fit the display without cutting any content off. This may leave some blank on either the top and bottom or the left and right of the screen.
 - ◆ **Auto cut:** Proportionally scales the video to fully fill the display. The content that goes out of the display range will be cut off.
 - ◆ **Resolution:** Click the drop-down list to select a resolution and refresh rate setting for the display device. This field is only available when the display is connected to the VP2120.
 - ◆ **Auto switching:** Automatically switches to a newly detected source. This option is only available for Display A.
 - ◆ **Display B:** Sets the display source, ratio, resolution, and auto switching for the connected display devices.
 - ◆ **Display Source:** Click the drop-down menu to select display source between HDMI and Streaming.
 - ◆ **Ratio:**
 - ◆ **Scale to whole:** Fully extends the video to the four sides of the display.
 - ◆ **Auto fit:** Proportionally scales the video to fit the display without cutting any content off. This may leave some blank on either the top and bottom or the left and right of the screen.
 - ◆ **Auto cut:** Proportionally scales the video to fully fill the display. The content that goes out of the display range will be cut off.
 - ◆ **Resolution:** Click the drop-down list to select a resolution and refresh rate setting for the display device. This field is only available when the display is connected to the VP2120.

- ◆ **Auto switching:** Automatically switches to a newly detected source. This option is only available for Display A.
- ◆ **OSD Notification**
 - ◆ **Display Time:** Sets the duration for which a notification message pops up in the OSD.
 - ◆ **Web Event:** Displays notifications on user actions performed via the web interface.
 - ◆ **System Event:** Displays notifications on system status, device connection status, and user actions performed via the OSD.

Maintenance

To access to the maintenance, log in the web interface as administrator, and then go to **System > Maintenance**.

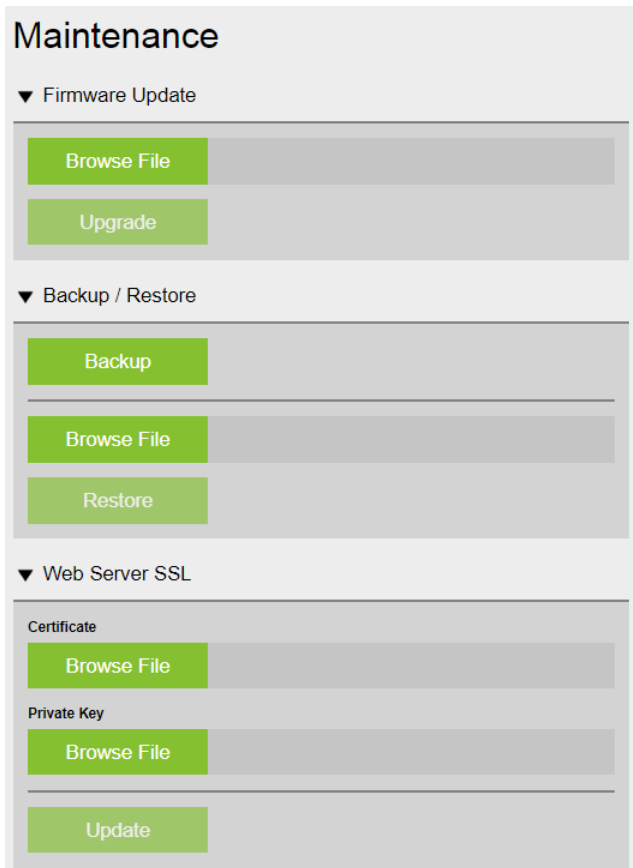

- ◆ **Firmware Upgrades:** Prepare the firmware file you wish to apply.
 - ◆ **Browse File:** Browse the firmware file that you have downloaded.
 - ◆ **Upgrade:** Click **Upgrade** when you have completed the above step, or the Upgrade button will be inaccessible.
-

Note:

- ◆ Please visit the product web page from <http://www.aten.com/global/en/>, in the **Support and Download** tab, download a firmware file.
 - ◆ When the upgrade is complete, a confirmation message.
-
- ◆ **Backup / Restore:** You can back up, export, and restore the VP2120's configuration, you can also reset the VP2120 to default settings. The backup will not include the username and password settings.
 - ◆ **Backup:** Click back up to back up your VP2120's configuration.
 - ◆ **Browse File:** Browse to locate a previously backed up file (.aes).
 - ◆ **Restore:** Click **Restore** when you have completed the above step, or the Restore button will be inaccessible.
 - ◆ **Reset to Default:** Reset all the settings, including network settings, to default.
 - ◆ **Web Server SSL:** To secure sessions between the VP2120 and web browsers accessing the VP2120's web interface, you can apply SSL encryption.
-

Note: Before you begin to encrypt SSL, you are required to purchase an SSL certificate from a trusted certificate authority and save the files to a computer with access to the VP2120's web interface.

- ◆ **Certificate:**
 - ◆ **Browse File:** Browse to upload the SSL certificate.
- ◆ **Private Key:**
 - ◆ **Browse File:** Browse to upload the SSL private key.
- ◆ **Update:** Click **Update** when you have completed the above two steps, or the Update button will be inaccessible.

Network Settings

To configure the VP2120's network connection settings, log in the web interface as administrator, and then go to **System > Network**.

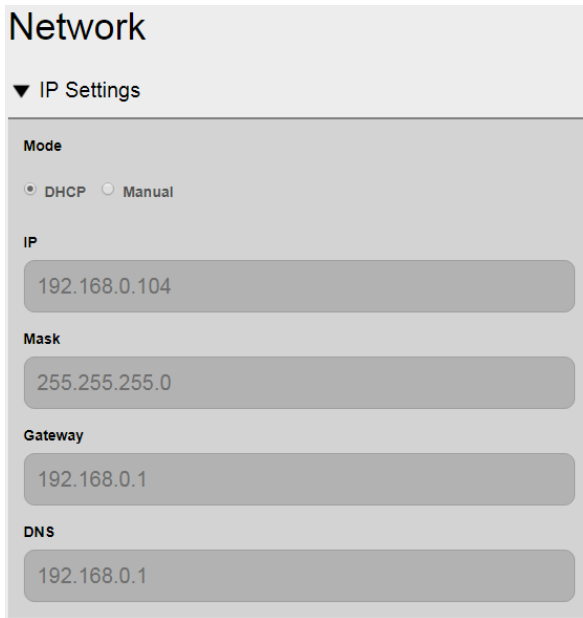

The screenshot displays the 'Network' configuration page. At the top, there is a dropdown menu for 'IP Settings' which is currently expanded. Below this, the 'Mode' section has two radio buttons: 'DHCP' (which is selected) and 'Manual'. The 'IP' field contains the value '192.168.0.104'. The 'Mask' field contains '255.255.255.0'. The 'Gateway' field contains '192.168.0.1'. The 'DNS' field contains '192.168.0.1'.

- ◆ **DHCP:** Select this option for the connected network switch to dynamically assign an IP address, subnet mask, gateway, and DNS to the VP2120.
- ◆ **Manual:** Select this option to manually type in an IP address, subnet mask, gateway, and DNS. The VP2120 does not require a reboot after the network setting is changed.

The Participant Account

When you log into the VP2120's web interface/App as participant, you are remotely connected to an online meeting where you can:

- ◆ View the video streamed out from the VP2120
- ◆ Interact with other meeting participants by instant messaging and share file.
- ◆ Share your screen to meeting participants
- ◆ Adjust audio, video, and general settings of the VP2120 from the control panel.

Joining a Meeting as Participant via Web Interface

1. In a web browser, type the web link (IP address) of the VP2120. This screen appears.

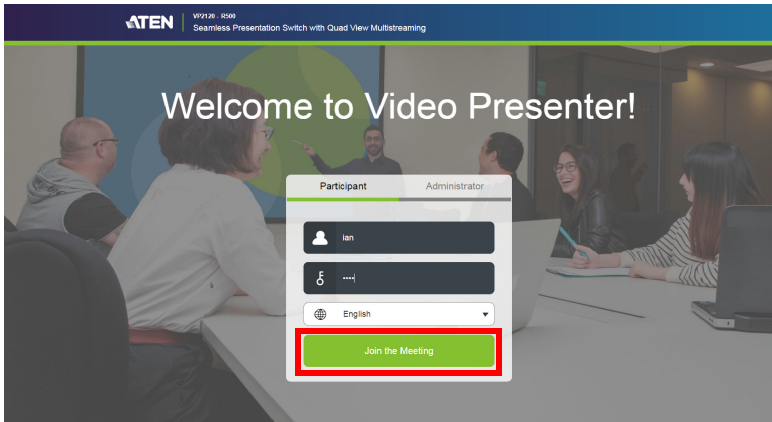

2. Type a display name of your choice.
3. If the room code is enabled on the VP2120, type the room code.



Note: To look up the room code, press the  pushbutton/button.

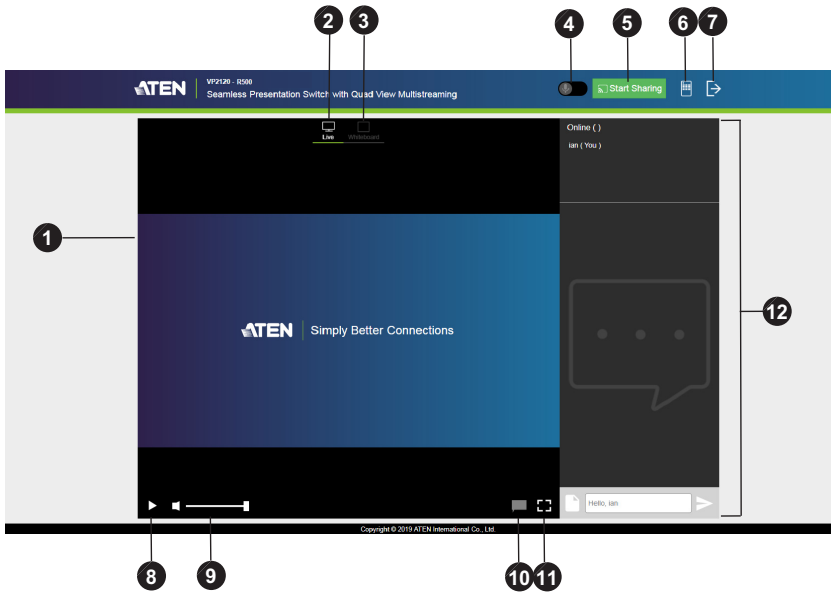

4. (Optional) Click the drop-down list to change the display language.
5. Click **Join the Meeting**. You are immediately logged into the web view of the meeting.

The Participant Screen

You can access the following controls when logged in as participant in the VP2120's web interface.



No.	Element	Description
1	Live Screen	Displays the content that goes live from the VP2120.
2	Live	When the green line appears under the icon it means your display is displaying live streaming content.
3	Whiteboard	When the green line appears under the icon it means your display is displaying the whiteboard. For more information, see <i>Whiteboard</i> , page 43.
4	Microphone 	Click to speak to the meeting members. Make sure your microphone is plugged to the VP2120 for this function to be available.
5		Click to share a screen or an application window from you PC or laptop to the VP2120 and makes it available for broadcast to all meeting participants. For details, see <i>Sharing a Screen or an Application Window</i> , page 42.

No.	Element	Description
6	Control Panel 	Click to access to the basic VP2120 settings. For more information, see <i>Control Panel</i> , page 46.
7	Log Out 	Click this button to log out the VP2120's web interface.
8	Play / Pause	You can play or pause the live streaming contents.
9	Volume Control	Allows you to tune the volume and click on the icon to mute.
10	Disable Chat Panel	Removes the chat room to make the display bigger.
11	Full Screen	Extends the display to full screen.
12	Chat Panel	Use this panel to instantly message and interact with other meeting participants.

Tip: Click the ATEN logo at the top-left corner to visit ATEN's official website.

Joining a Meeting as Participant via App

The ATEN Video Presentation Control App allows users to connect to the VP2120 wirelessly using smartphones/tablets to join a meeting and share contents.



Requirements

- ◆ Make sure your mobile device uses a supported version of the mobile operating system listed below before installing the app.

Mobile Operating System	Supported Version
iOS	12.0 or later
Android	8.0 or later

- ◆ Make sure to connect the mobile device to the network where the VP2120 is installed.

Procedure

1. Install the Video Presentation Control App on a mobile device.
 - a) From the mobile device, tap the **App Store**  or **Google Play**  icon.
 - b) In the search box, type "ATEN Video Presentation Control App".
 - c) Tap **ATEN Video Presentation Control App** and install the app.
2. From the mobile device, tap the **ATEN Video Presentation Control App** icon .
3. Follow the steps below to log in the meeting.

For more information on the ATEN Video Presentation Control App, refer to the *ATEN Video Presentation Control App User Manual*.

iOS

- a) Open the ATEN Video Presentation Control App from your mobile device.

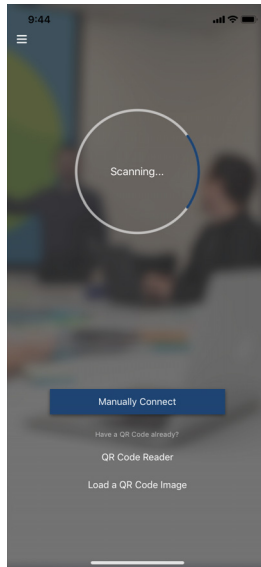

- b) When the scanning finishes, the Room List appears. Tap on a room to join the meeting.

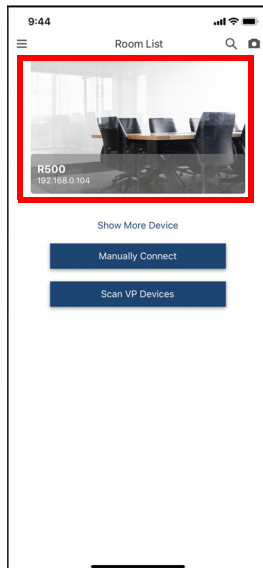

c) Tap **Join Room**.

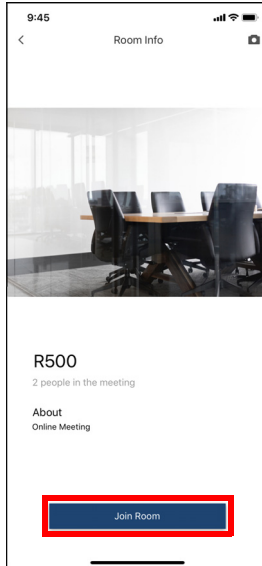

d) Enter a room code, and then tap **Connect**.

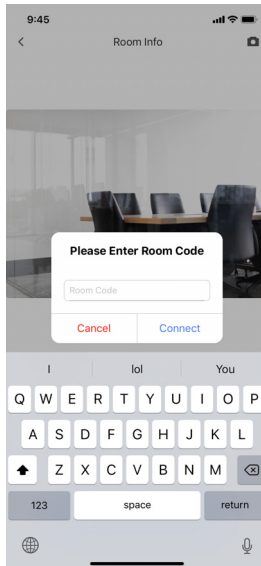

e) Now you have successfully joined the meeting.



f) Tap on the screen and then tap **Start Sharing** to share your content.

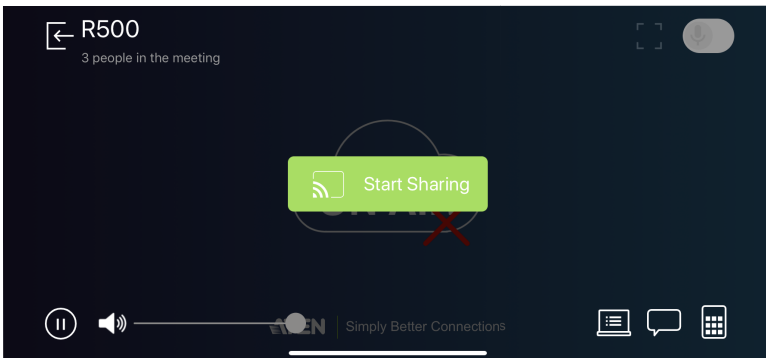

Android

- a) Open the ATEN Video Presentation Control App from your mobile device.

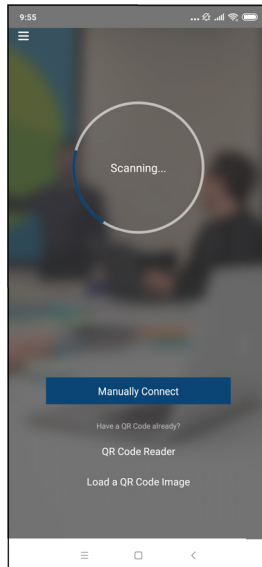

- b) When the scanning finishes, the Room List appears. Tap on a room to join the meeting.

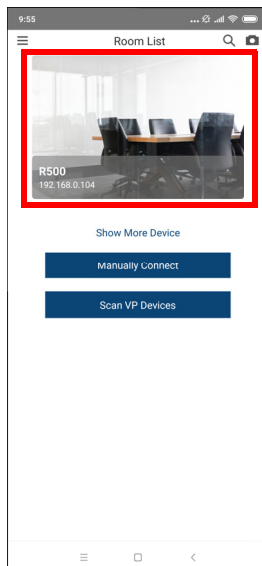

c) Tap **Join Room**.

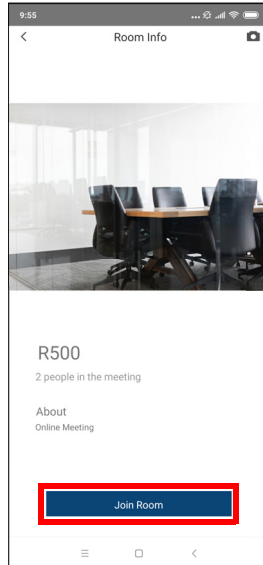

d) Enter a room code, and then tap **Connect**.

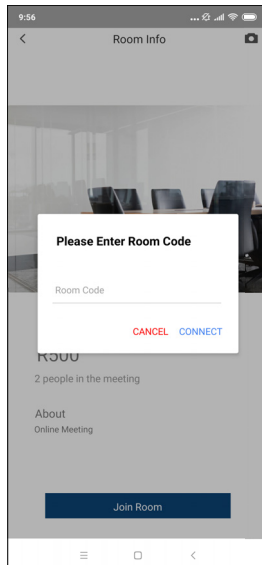

e) Now you have successfully joined the meeting.

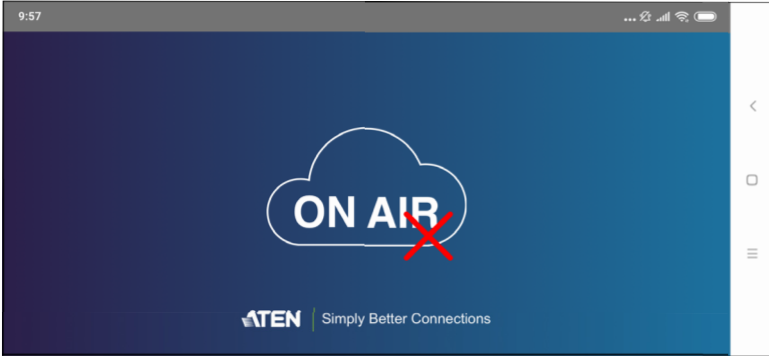

f) Tap on the screen and then tap **Start Sharing** to share your content

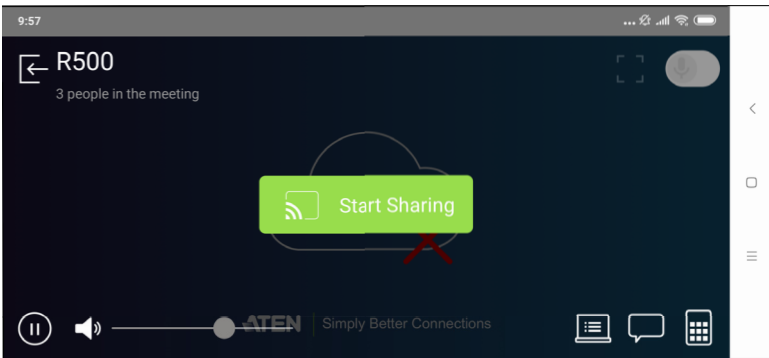

Safety Instructions

General

- ◆ This product is for indoor use only.
- ◆ Read all of these instructions. Save them for future reference.
- ◆ Follow all warnings and instructions marked on the device.
- ◆ Do not place the device on any unstable surface (cart, stand, table, etc.). If the device falls, serious damage will result.
- ◆ Do not use the device near water.
- ◆ Do not place the device near, or over, radiators or heat registers.
- ◆ The device cabinet is provided with slots and openings to allow for adequate ventilation. To ensure reliable operation, and to protect against overheating, these openings must never be blocked or covered.
- ◆ The device should never be placed on a soft surface (bed, sofa, rug, etc.) as this will block its ventilation openings. Likewise, the device should not be placed in a built in enclosure unless adequate ventilation has been provided.
- ◆ Never spill liquid of any kind on the device.
- ◆ Unplug the device from the wall outlet before cleaning. Do not use liquid or aerosol cleaners. Use a damp cloth for cleaning.
- ◆ The device should be operated from the type of power source indicated on the marking label. If you are not sure of the type of power available, consult your dealer or local power company.
- ◆ The device is designed for IT power distribution systems with 230V phase-to-phase voltage.
- ◆ To prevent damage to your installation it is important that all devices are properly grounded.
- ◆ The device is equipped with a 3-wire grounding type plug. This is a safety feature. If you are unable to insert the plug into the outlet, contact your electrician to replace your obsolete outlet. Do not attempt to defeat the purpose of the grounding-type plug. Always follow your local/national wiring codes.

- ◆ Do not allow anything to rest on the power cord or cables. Route the power cord and cables so that they cannot be stepped on or tripped over.
- ◆ If an extension cord is used with this device make sure that the total of the ampere ratings of all products used on this cord does not exceed the extension cord ampere rating. Make sure that the total of all products plugged into the wall outlet does not exceed 15 amperes.
- ◆ To help protect your system from sudden, transient increases and decreases in electrical power, use a surge suppressor, line conditioner, or uninterruptible power supply (UPS).
- ◆ Position system cables and power cables carefully; Be sure that nothing rests on any cables.
- ◆ Never push objects of any kind into or through cabinet slots. They may touch dangerous voltage points or short out parts resulting in a risk of fire or electrical shock.
- ◆ Do not attempt to service the device yourself. Refer all servicing to qualified service personnel.
- ◆ If the following conditions occur, unplug the device from the wall outlet and bring it to qualified service personnel for repair.
 - ◆ The power cord or plug has become damaged or frayed.
 - ◆ Liquid has been spilled into the device.
 - ◆ The device has been exposed to rain or water.
 - ◆ The device has been dropped, or the cabinet has been damaged.
 - ◆ The device exhibits a distinct change in performance, indicating a need for service.
 - ◆ The device does not operate normally when the operating instructions are followed.
- ◆ Only adjust those controls that are covered in the operating instructions. Improper adjustment of other controls may result in damage that will require extensive work by a qualified technician to repair.

Rack Mounting

- ◆ Before working on the rack, make sure that the stabilizers are secured to the rack, extended to the floor, and that the full weight of the rack rests on the floor. Install front and side stabilizers on a single rack or front stabilizers for joined multiple racks before working on the rack.
- ◆ Always load the rack from the bottom up, and load the heaviest item in the rack first.
- ◆ Make sure that the rack is level and stable before extending a device from the rack.
- ◆ Use caution when pressing the device rail release latches and sliding a device into or out of a rack; the slide rails can pinch your fingers.
- ◆ Do not overload the AC supply branch circuit that provides power to the rack. The total rack load should not exceed 80 percent of the branch circuit rating.
- ◆ Make sure that all equipment used on the rack – including power strips and other electrical connectors – is properly grounded.
- ◆ Ensure that proper airflow is provided to devices in the rack.
- ◆ Ensure that the operating ambient temperature of the rack environment does not exceed the maximum ambient temperature specified for the equipment by the manufacturer.
- ◆ Do not step on or stand on any device when servicing other devices in a rack.

Technical Support

International

- ◆ For online technical support – including troubleshooting, documentation, and software updates: <http://support.aten.com>
- ◆ For telephone support, call this number:

International	886-2-8692-6959
China	86-400-810-0-810
Japan	81-3-5615-5811
Korea	82-2-467-6789
North America	1-888-999-ATEN ext 4988 1-949-428-1111

North America

Email Support		support@aten-usa.com
Online Technical Support	Troubleshooting Documentation Software Updates	http://www.aten-usa.com/support
Telephone Support		1-888-999-ATEN ext 4988

When you contact us, please have the following information ready beforehand:

- ◆ Product model number, serial number, and date of purchase
- ◆ Your computer configuration, including operating system, revision level, expansion cards, and software
- ◆ Any error messages displayed at the time the error occurred
- ◆ The sequence of operations that led up to the error
- ◆ Any other information you feel may be of help

Specifications

Function	VP2120
Video Input	
Interfaces	1 x HDMI Type-A Female (Black)
Video Output	
Interfaces	2 x HDMI Type-A Female (Black)
Max. Distance	HDMI: Up to 15 m
Video	
Max. Resolutions	HDMI: Up to 1080p @ 60 Hz
Compliance	HDMI: HDCP 1.4 Compatible Consumer Electronics Control (CEC)
Audio	
Input	Microphone: 1 x Mini Stereo Jack Female (Pink)
Output	Stereo Audio: 1 x Mini Stereo Jack Female (Green)
Connectors	
Console Ports	USB 3.0: 1 x USB Type-A Female (Blue)
Power	1 x DC Jack (Black)
Control	
IR	1 x Mini Stereo Jack Female (Black)
Ethernet	1 x RJ-45 Female (Silver)
Switches	
Power	1 x Pushbutton (LED: Green)
Selection	Room Info: 1 x Pushbutton Menu: 1 x Pushbutton Left: 1 x Pushbutton Right: 1 x Pushbutton Down: 1 x Pushbutton Up/Unlock: 1 x Pushbutton Volume: 1 x Knob Enter: 1 x Pushbutton Esc: 1 x Pushbutton
EDID Settings	EDID Mode: ATEN Default / Display A
Power	
Consumption	DC12V:14.46W:87BTU
Environmental	

Function	VP2120
Operating Temperature	0 - 40°C
Storage Temperature	-20 - 60°C
Humidity	0 x 80% RH, Non-Condensing
Physical Properties	
Housing	Metal
Weight	1.14 kg (2.51 lb)
Dimensions (L x W x H)	20.00 x 16.92 x 4.40 cm (7.87 x 6.66 x 1.73 in)

Limited Warranty

ATEN warrants its hardware in the country of purchase against flaws in materials and workmanship for a Warranty Period of two [2] years (warranty period may vary in certain regions/countries) commencing on the date of original purchase. This warranty period includes the LCD panel of ATEN LCD KVM switches. Select products are warranted for an additional year (see *A+ Warranty* for further details). Cables and accessories are not covered by the Standard Warranty.

What is covered by the Limited Hardware Warranty

ATEN will provide a repair service, without charge, during the Warranty Period. If a product is defective, ATEN will, at its discretion, have the option to (1) repair said product with new or repaired components, or (2) replace the entire product with an identical product or with a similar product which fulfills the same function as the defective product. Replaced products assume the warranty of the original product for the remaining period or a period of 90 days, whichever is longer. When the products or components are replaced, the replacing articles shall become customer property and the replaced articles shall become the property of ATEN.

To learn more about our warranty policies, please visit our website:

<http://www.aten.com/global/en/legal/policies/warranty-policy>